

Stationaire opbouw
Benne lisse (caisse fixe) 25 mm
Mulden

F-1-1

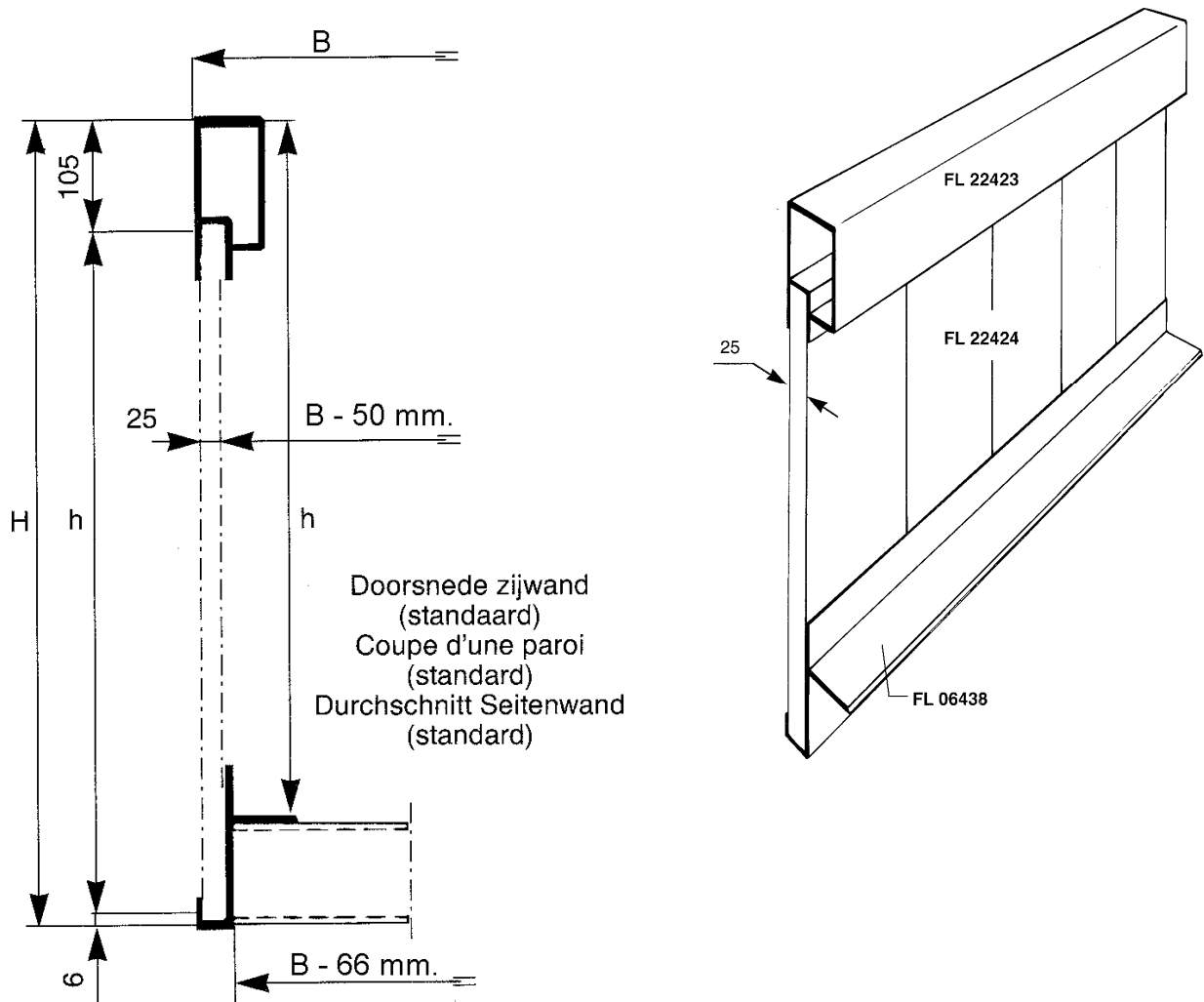

Blz. Page Seite	Profiel nr. Nr. de profil Profil Nr.	Gewicht Poids Gewicht	Symbool Symbole Symbol	Beschrijving Description Bezeichnung	Lengte Longueur Länge
F-1-2	FL 06438	3,80 kg/m		Onderrandprofiel Rive inférieure Untergurtprofil	13,00 m
	FL 22424	3,80 kg/m (15,2 kg/m ²)	 250 mm	Zijwandprofiel Profilé de paroi Wandprofil	*

Leverbaar af fabriek;

Livvable d'usine;

Lieferbar ab Werk.

	AL 30677	5,99 kg/m (14,98 kg/m ²)	 400 x 25 mm	Zijwandprofiel Profilé de paroi Wandprofil	* Min. 2000 kg.
	FL 22423	5,30 kg/m		Bovenrandprofiel Profilé supérieur Obergurtprofil	*

Stationaire opbouw
 Benne lisse (caisse fixe) 25 mm
 Mulden

F-1-2

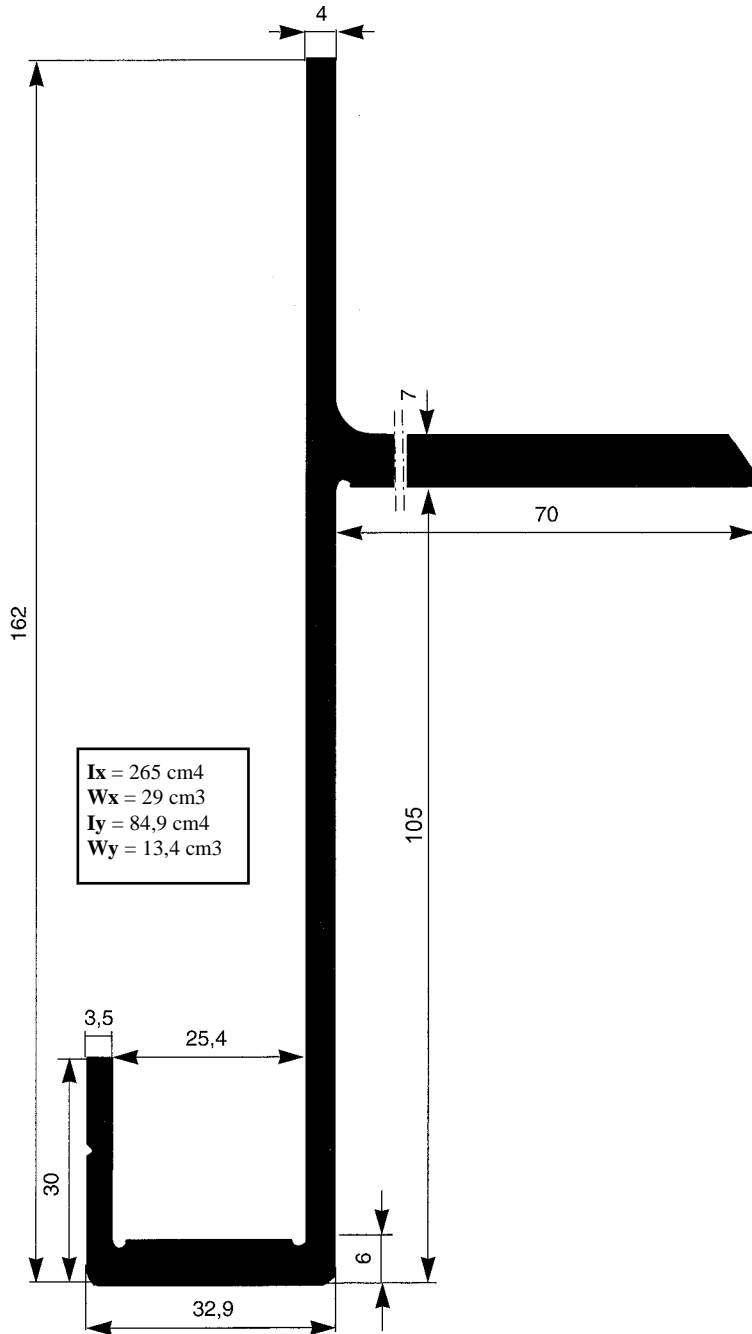

FL 06438
 3,80 kg/m
 code
 415631 13,00 m

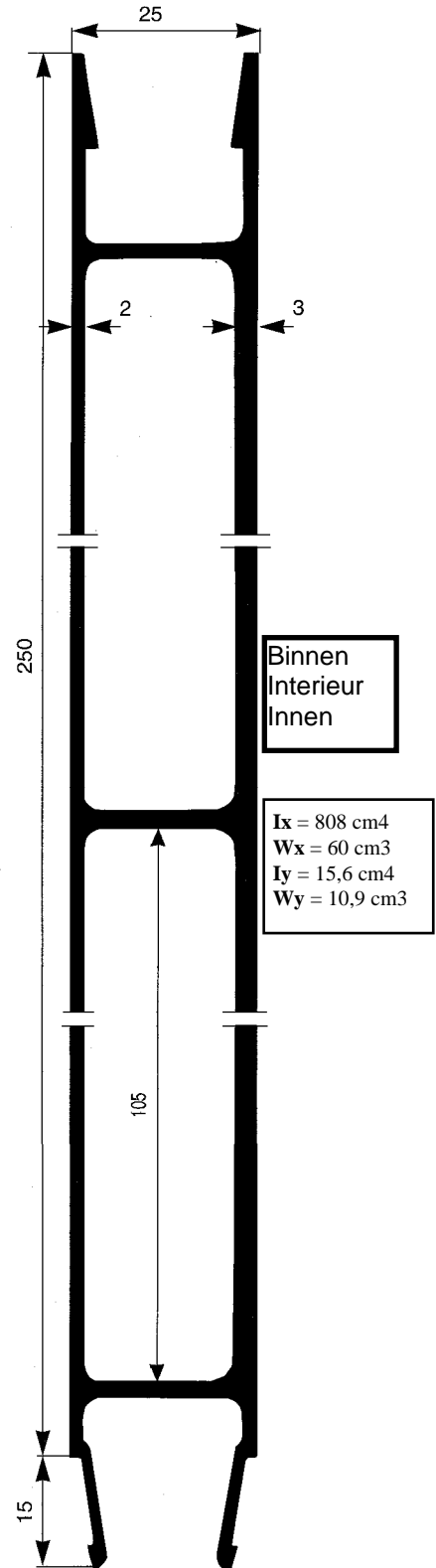

FL 22424
 3,80 kg/m





*

Stationaire opbouw
Fond mouvant
Mulden

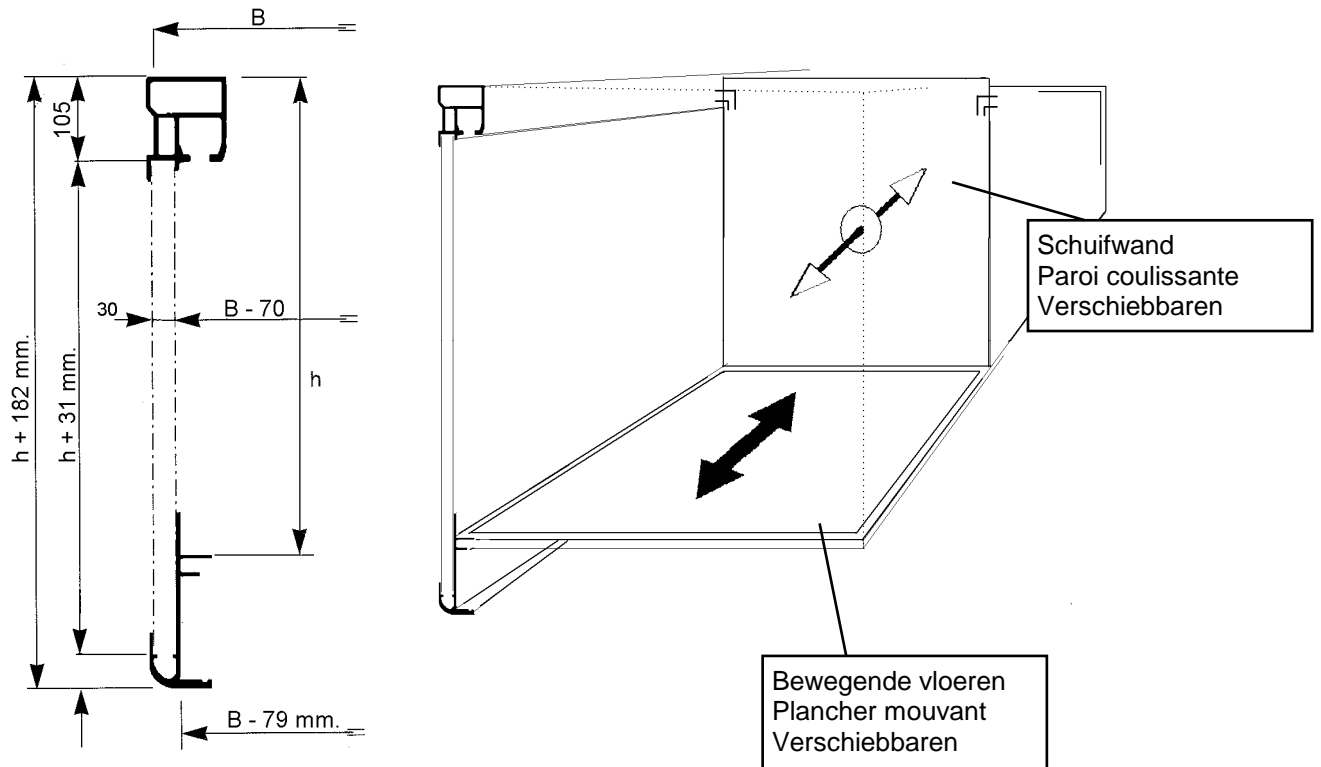
F-2-1

30mm

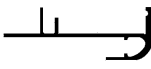
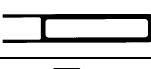

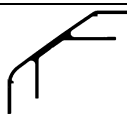
Blz. Page Seite	Profiel nr. Nr. de profil Profil Nr.	Gewicht Poids Gewicht	Symbol Symbole Symbol	Beschrijving Description Bezeichnung	Lengte Longueur Länge
F-2-2	CH 57241	7,25 kg/m		Bovenrandprofiel Profilé supérieur Obergurtprofil	13,60 m
	AN 831	4,00 kg/m (11,2 kg/st-p)		Scharnier compleet Charnière complète Scharnier Komplett	L=2800 mm.
F-2-3	CH 57899	6,80 kg/m		Onderrandprofiel Rive inférieure Untergurtprofil	13,70 m
	FL 27628	7,51 kg/m		Achterstijlprofiel Montant arrière Eckprofil-hinten	7,50 m
F-2-4	FL 10470	7,04 kg/m		Dwarsligger Traverse	5,05 m
	CH 57503	4,14 kg/m		Querträger	5,05 m
F-2-5	FL 11731	4,47 kg/m		Hoekprofiel Profilé de coin Eckprofil	6,00 m

Stationaire opbouw
 Caisse pour plancher mouvant 30mm
 Mulden

F-2-3

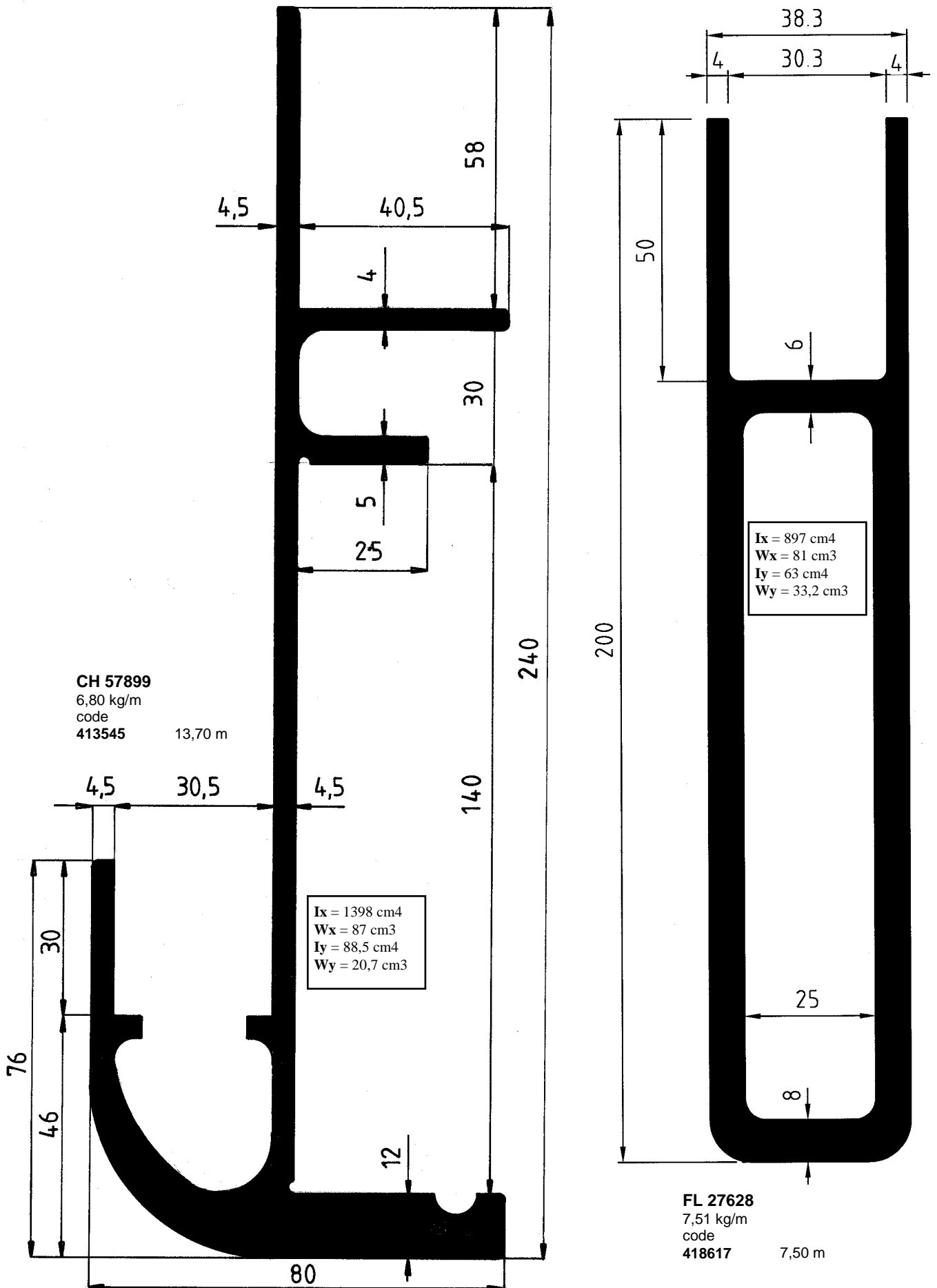

Stationaire opbouw
Caisse pour plancher mouvant 30mm
Mulden

F-2-4

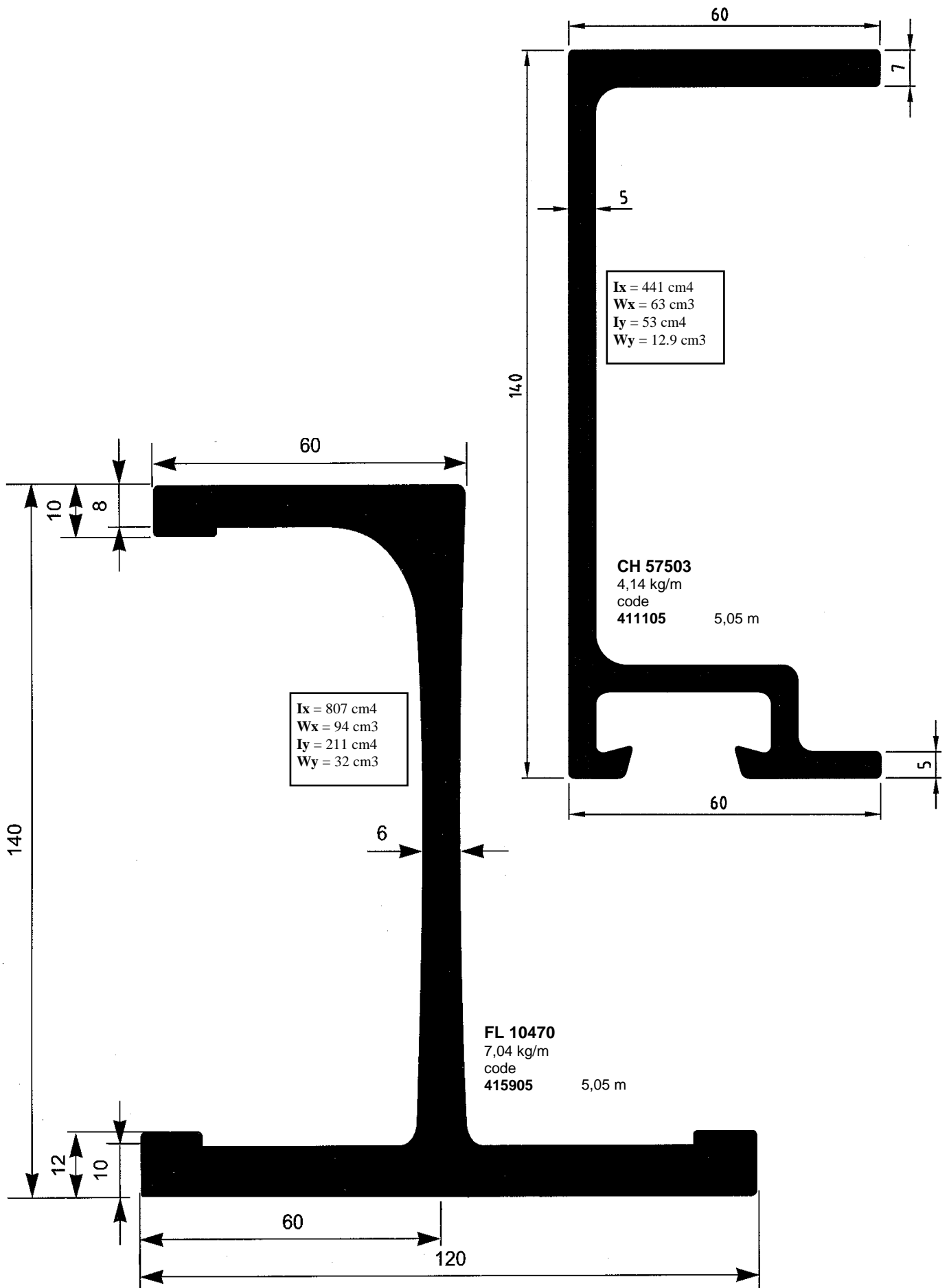

Stationaire opbouw
Caisse pour plancher mouvant 30mm
Mulden

F-2-5

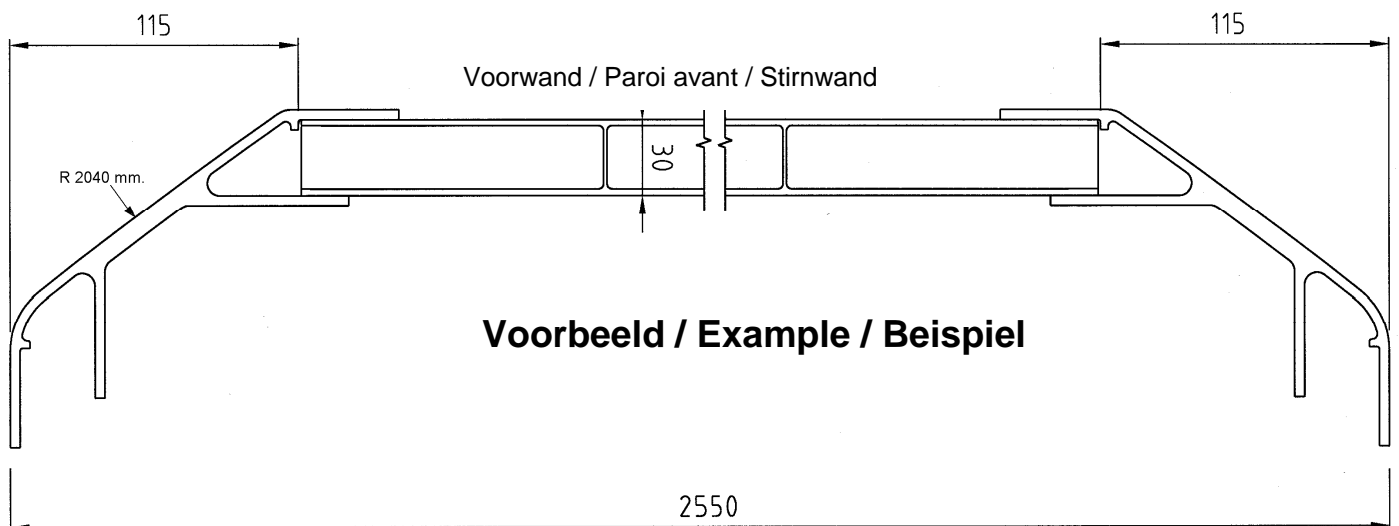
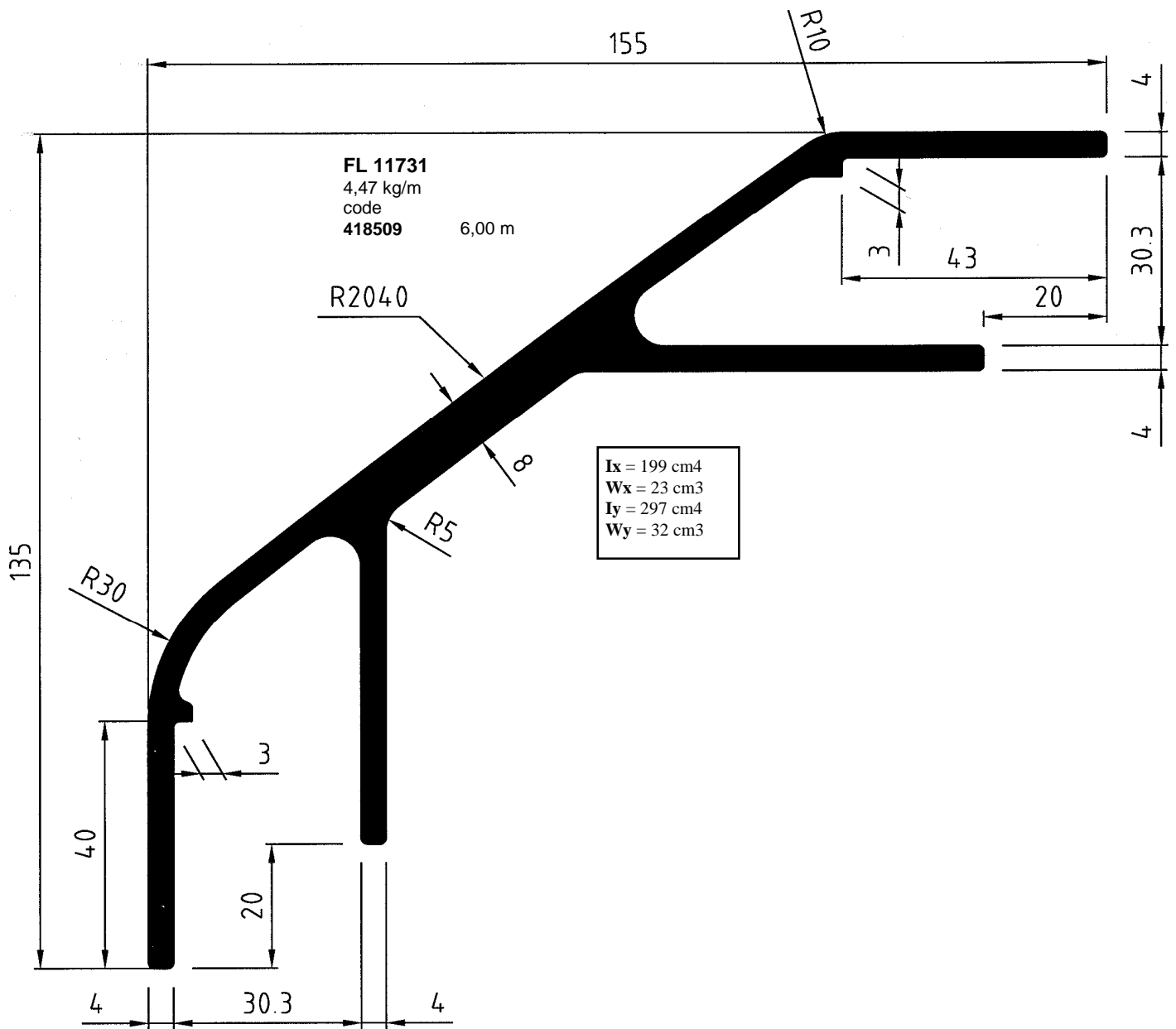

Kipper Benne lisse Kippermulden

F-3-1

30mm

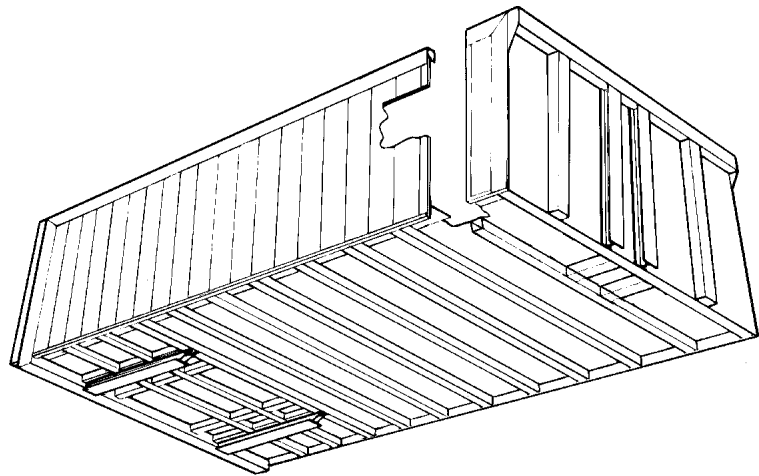
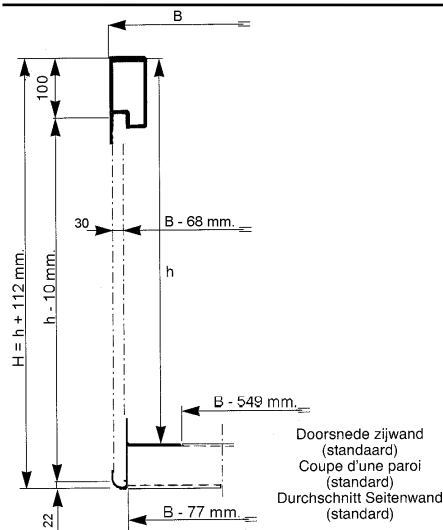









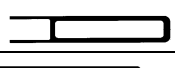
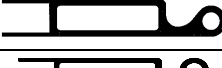









Blz. Page Seite	Profiel nr. Nr. de profil Profil Nr.	Gewicht Poids Gewicht	Symbol Symbole Symbol	Beschrijving Description Bezeichnung	Lengte Longueur Länge
F-3-3	FL 23417	5,30 kg/m		Hoekprofiel Profilé de coin Eckprofil	7,50 m
F-3-4	FL 23402	5,80 kg/m		Bovenrandprofiel Profilé supérieur Obergurtprofil	8,50 m 11,50 m 13,60 m
	CH 58818	7,46 kg/m		Onderrandprofiel Rive inférieure Untergurtprofil	8,50 m 11,00 m 13,00 m
F-3-5	CH 55810	9,85 kg/m (16,98 kg/m ²)		Zijwandprofiel Profilé de paroi	5,00 m 6,05 m 5,50 m 6,60 m
	AL 59244	9,91 kg/m (16,52 kg/m ²)		Profilé de paroi Wandprofil	*
	AS 08392	0,03 kg/st-p		Klemveer Ressort de liaison Wendelfeder	
F-3-6	FL 21844	4,00 kg/m (16,0 kg/m ²)		Zijwandprofiel Profilé de paroi	4,50 m 5,50 m 5,00 m 6,00 m
	FL 28991	5,38 kg/m (15,4 kg/m ²)		Wandprofil	*
F-3-7	DC 06864	3,59 kg/m		Dwarsligger Traverse Querträger	6,00 m
	CH 56743	4,90 kg/m			5,05 m
	FL 02777	4,00 kg/m			5,05 m
	CH 56744	6,00 kg/m			5,05 m
F-3-8	FL 02493	5,80 kg/m		Dwarsligger Traverse	6,00 m
	FL 01998	8,10 kg/m		Querträger	6,00 m
F-3-9	CH 49045	8,80 kg/m		Cilinder bevestiging Support verin Pressanschluss	6,00 m 7,20 m
	CH 49041	13,80 kg/m		Kip-scharnier Charnière de bennage Kipplagerprofil	6,00 m

**Kipper
Benne lisse
Kippermulden**

30mm

F-3-2

Blz. Page Seite	Profiel nr. Nr. de profil Profil Nr.	Gewicht Poids Gewicht	Symbol Symbole Symbol	Beschrijving Description Bezeichnung	Lengte Longueur Länge
F-3-10	FL 25463	6,37 kg/m		Achterstijlprofiel Montant arrière	7,50 m
	FL 27628	7,51 kg/m		Eckprofil-hinten	7,50 m
F-3-11	FL 26481	10,09 kg/m		Achterstijlprofiel	7,50 m
	FT61974	10,56 kg/m		Montant arrière Eckprofil-hinten	7,50 m
F-3-12	FL 07439	0,90 kg/m		Afsluitprofiel Profilé de battée Schlussprofil	6,00 m
	AN 587	0,11 kg/m		Afdichtrubber Joint Dichtung	40 m
	FL 07438	3,85 kg/m		Deurrandprofiel Rive de porte	5,00 m
	DC 06864	3,59 kg/m		Türgurtprofiel	6,00 m
F-3-13	FL 25246	4,97 kg/m		Deurprofiel Profilé de porte Türrahmenprofil	5,50 m
	AN 736	0,38 kg/m		Afdichtrubber Joint Dichtung	30 m
	FL 25245	4,02 kg/m		Deurprofiel Profilé de porte Türrahmenprofil	5,60 m
F-3-14	FL 06119	0,74 kg/m		Graanschuifprofiel Glissière de porte Führungsprofil	6,00 m
	FL 23064	3,75 kg/m		Deurscharnierprofiel	6,00 m
	FL 23065	3,55 kg/m		Profilé de charnière de porte	6,00 m
	FL 26482	5,71 kg/m		Türscharnierprofiel	7,50 m
F-3-15	FL 27505	4,91 kg/m		Deurscharnierprofiel Profilé de charnière de porte	* 6,50 m
	FL 27506	4,85 kg/m		Türscharnierprofiel	* 5,50 m
	AN 771	0,01 kg/st		Lagerbus kunststof Ø 35/25*21 mm Bague épaulée Lagerungs Buchse Kunststoff	*

	FL 28185	6,44 kg/m	 100*130/160 mm	Bovenrandprofiel Profilé supérieur Obergurtprofil	*
C-1-4	AL 50221	3,45 kg/m		Onderrandprofiel Rive inférieure Untergurtprofil	7,50 m

* Leverbaar af fabriek;

Livable d'usine;

Lieferbar ab Werk.

Kipper
Benne lisse
Kippermulden

30mm

F-3-3

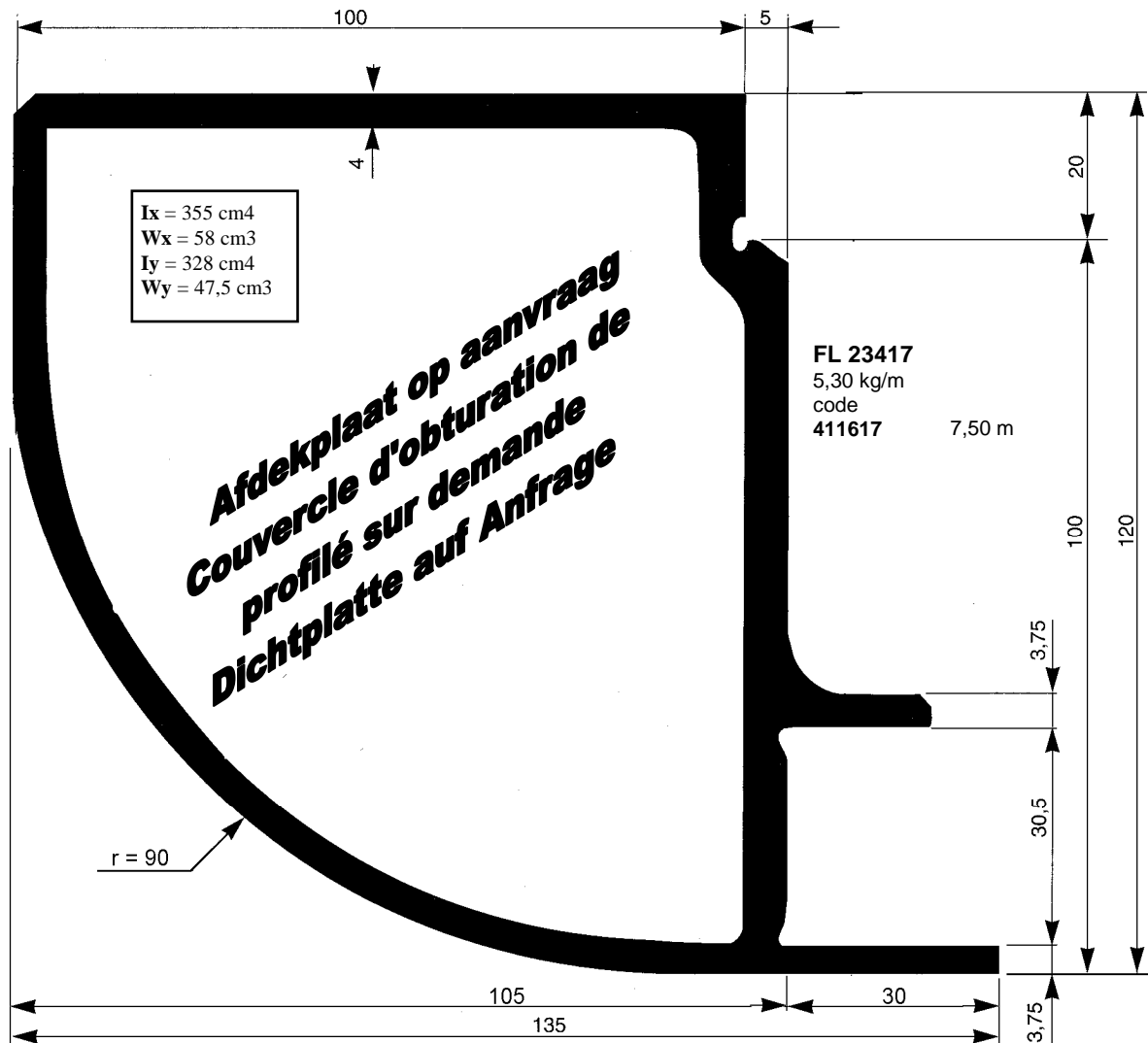

Platen	Tôles	Bleche				
Code	Dikte Epaisseur Dicke	Afmetingen Dimensions Abmessungen	Legering - Alliage - Legierung AlMg4,5Mn EN 5083 H 111	kg/st-p	kg/m ²	
			Buigradius 2 * plaatdikte			
3044	4,0	2000 x 6000	Bon pour le pliage	130,80	10,90	
3047	6,0	2000 x 6000	R de pliage 2 * épaisseur	196,20	16,35	
147280	8,0	2000 x 6000	Gut zum biegen	261,60	21,80	
147210	10,0	2000 x 6000	Biegeradius 2 * Blechdicke	327,00	27,25	
1104206	6,0	2000 x 6000	Legering - Alliage - Legierung	Vloerplaat Tôle de fond	196,20	16,35
1104207	8,0	2000 x 6000	ENDUR-AL EN 5456 H 34	Bodem Blech	261,60	21,80
142230	3,0	2000 x 6000	Legering - Alliage - Legierung	Vloerplaat	98,10	8,18
142240	4,0	2000 x 6000	Legierung	Tôle de fond	130,80	10,90
142250	5,0	2000 x 6000	AlMg4,5Mn	Bodem Blech	163,50	13,63
142555	5,0	2500 x 6000	EN 5083 H 321		204,38	13,63
142260	6,0	2000 x 6000			196,20	16,35
1104436	6,0	2500 x 6000			245,25	16,35
1104150	6,0	2400 x 7000			274,68	16,35
142270	7,0	2000 x 6000			228,90	19,08
142370	7,0	2400 x 6000			274,68	19,08
142280	8,0	2000 x 6000			261,60	21,80
142310	10,0	2000 x 6000			327,00	27,25

**Kipper
Benne lisse
Kippermulden**

30mm

F-3-4

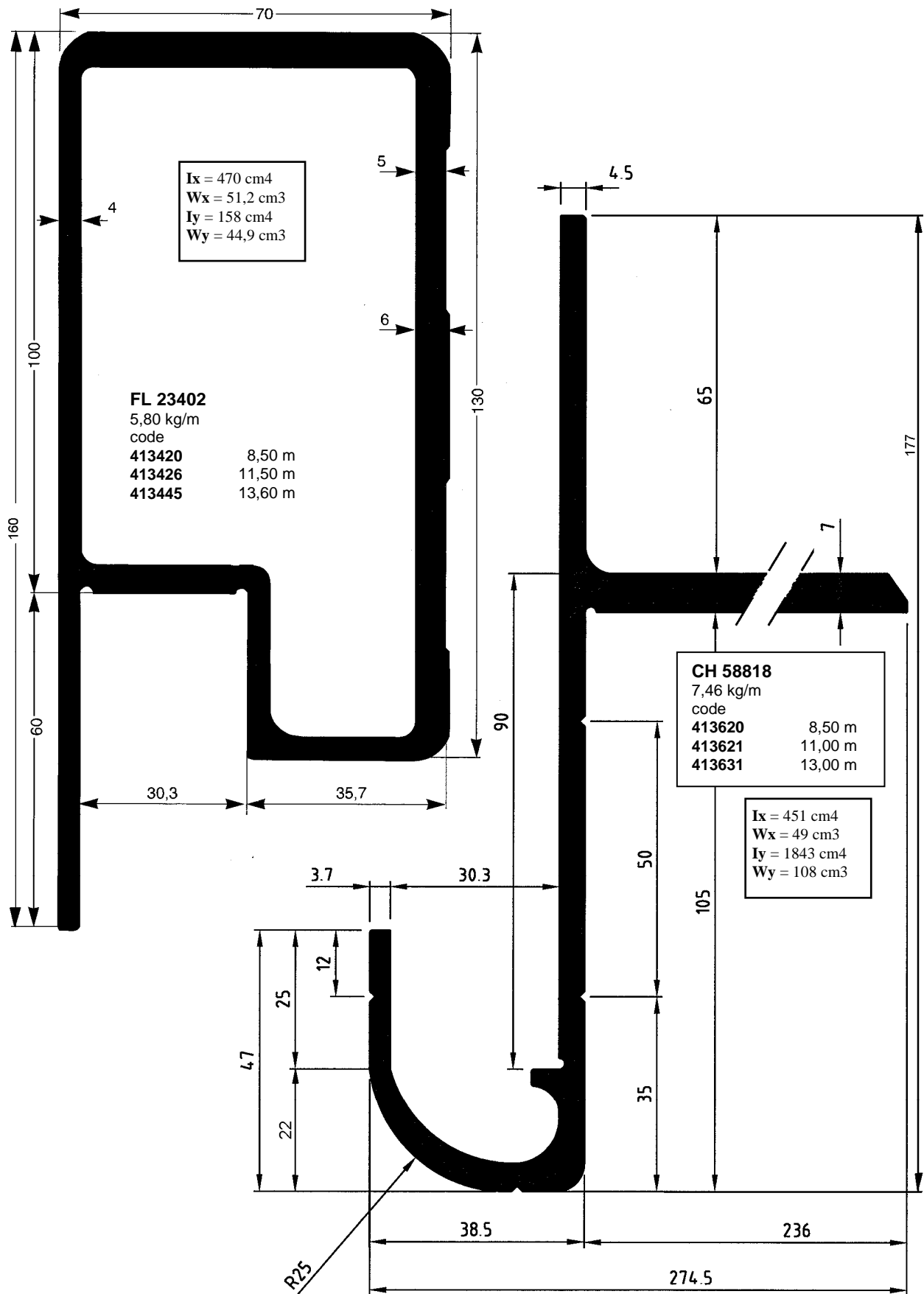

**Kipper
Benne lisse
Kippermulden**

F-3-5

30mm

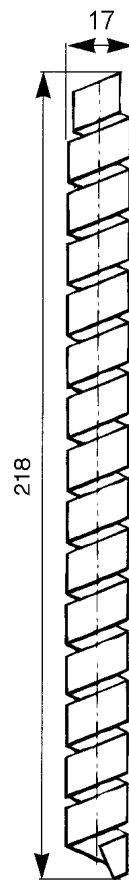
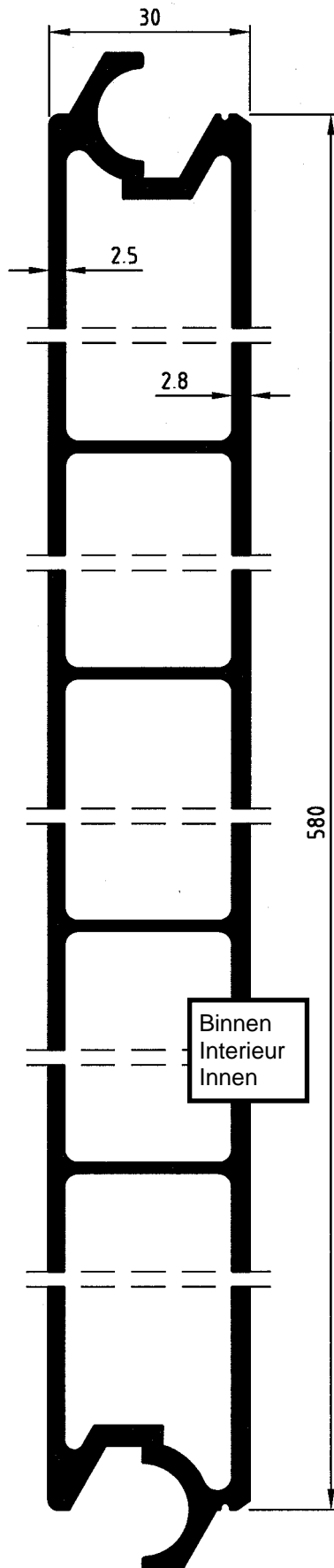

AS 08392
0,03 kg/st-p
code
647351

Binnen
Interieur
Innen

CH 55810
9,85 kg/m
code
412605 5,00 m
412607 5,50 m
412606 6,05 m
412612 6,60 m

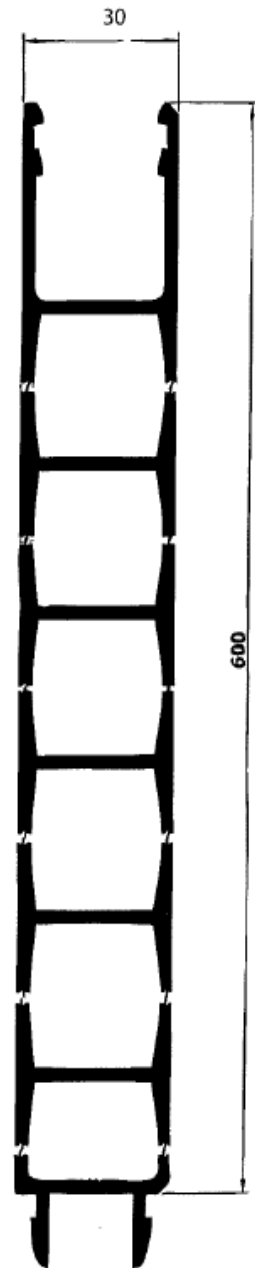
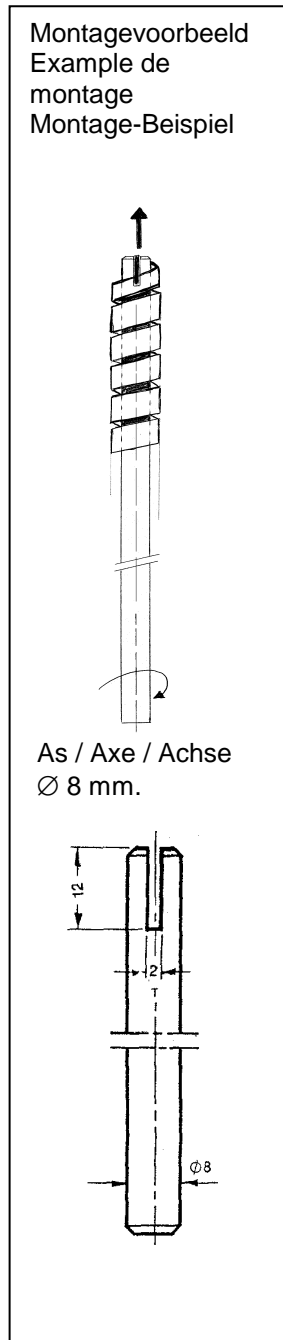

AL 59244
9,91 kg/m
*

**Kipper
Benne lisse
Kippermulden**

30mm

F-3-6

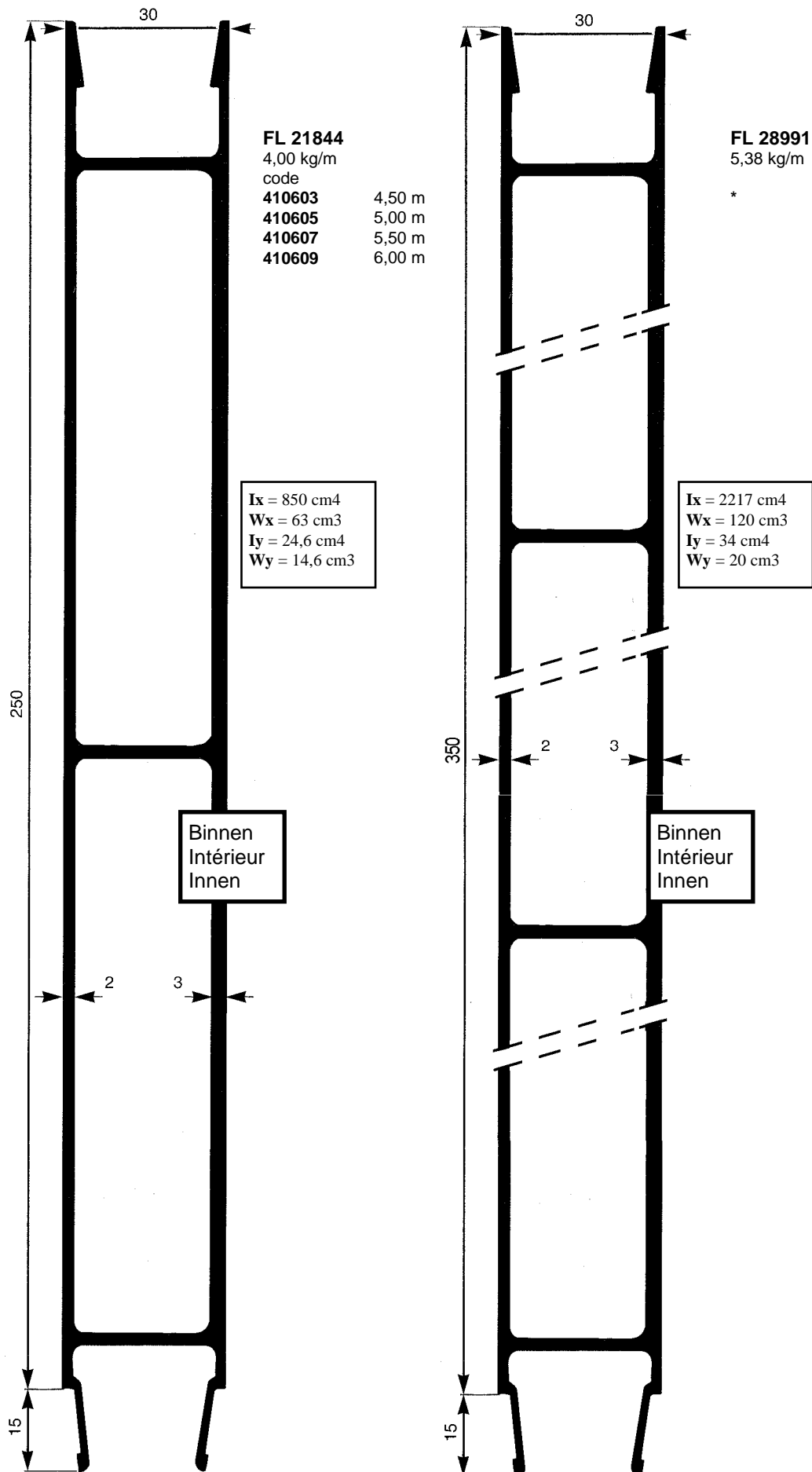

**Kipper
Benne lisse
Kippermulden**

30mm

F-3-7

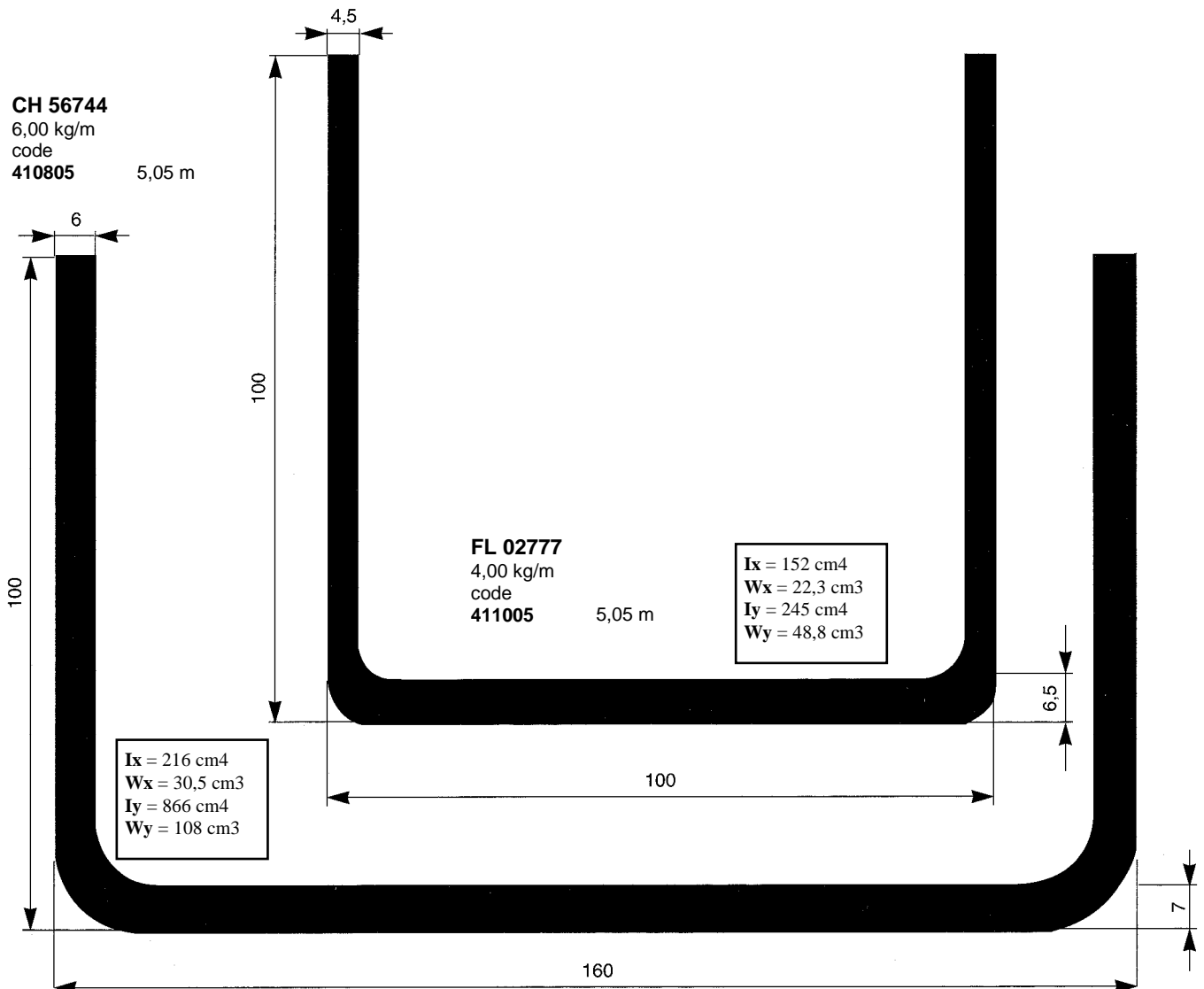
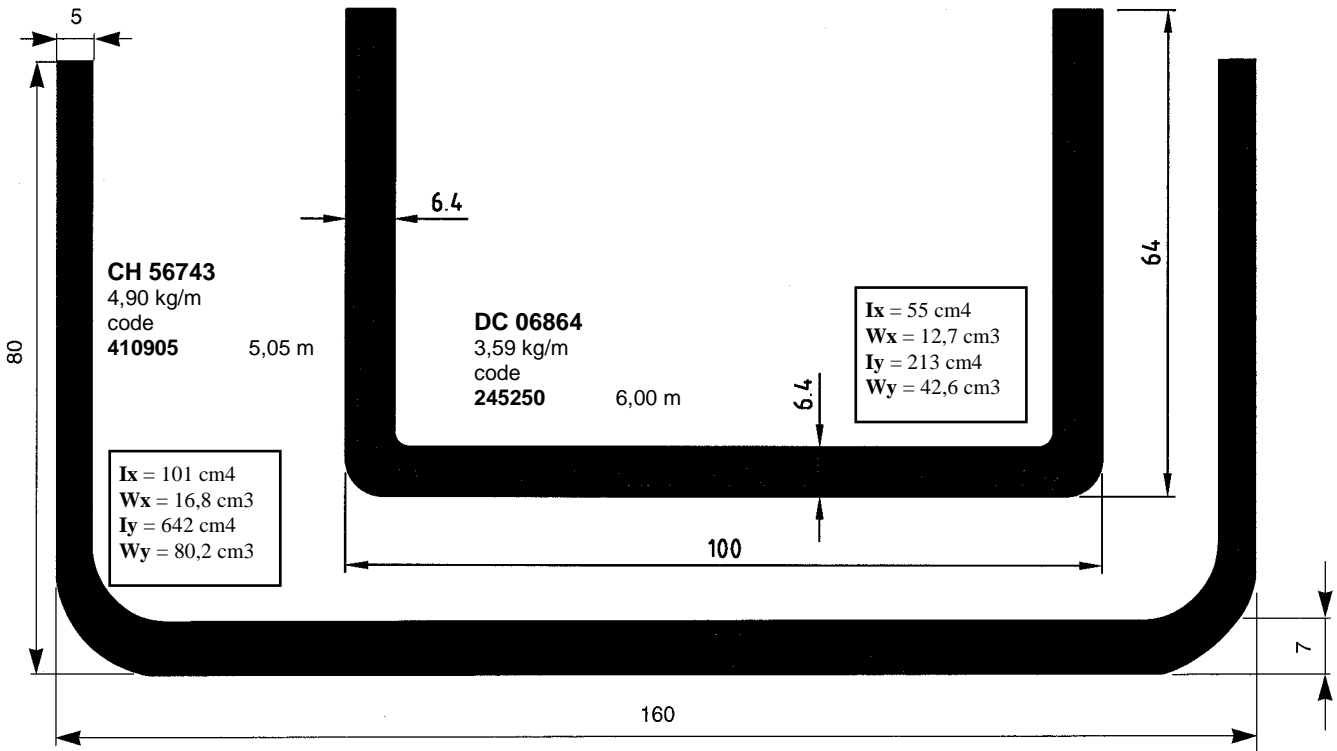

Kipper
Benne lisse
Kippermulden

30mm

F-3-8

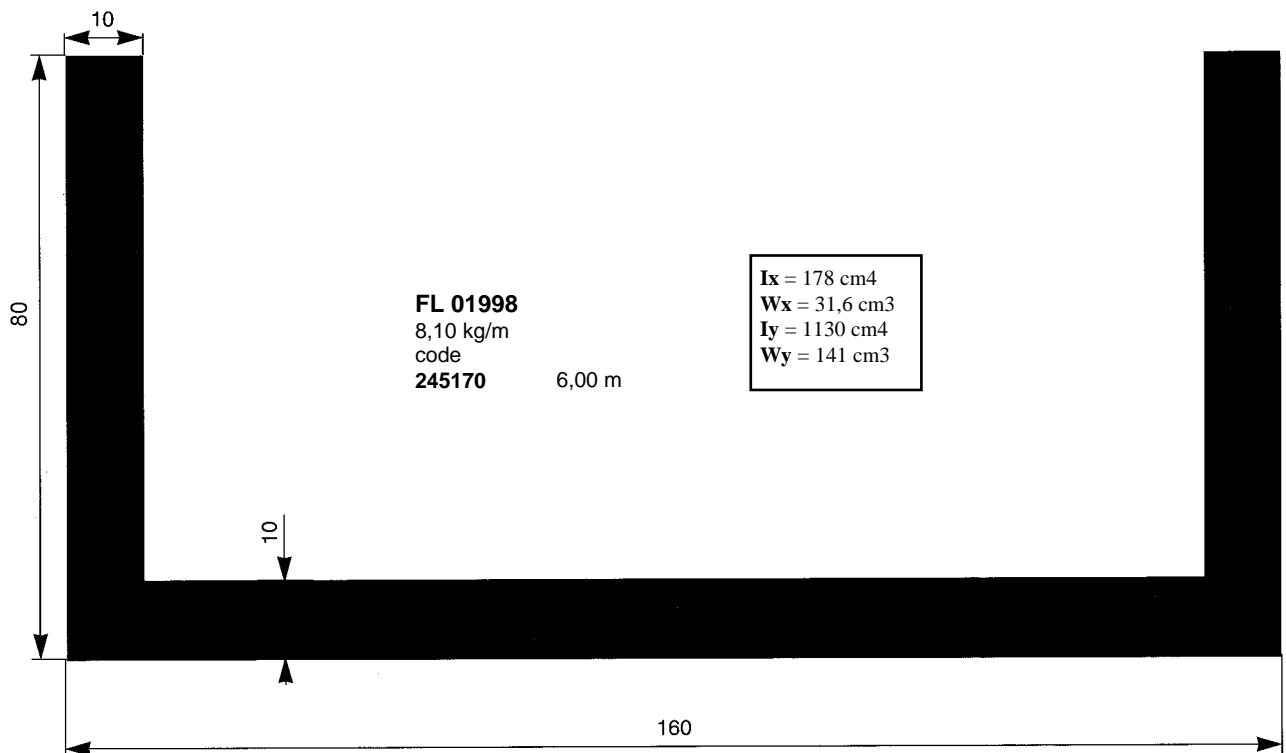
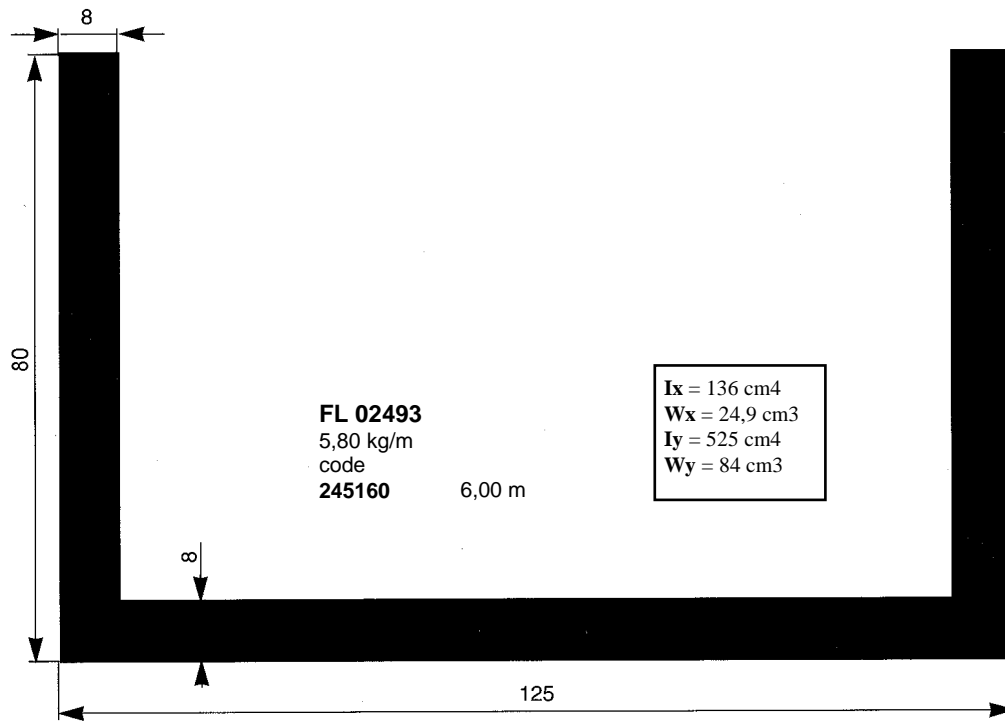

Kipper
Benne lisse
Kippermulden

30mm

F-3-9

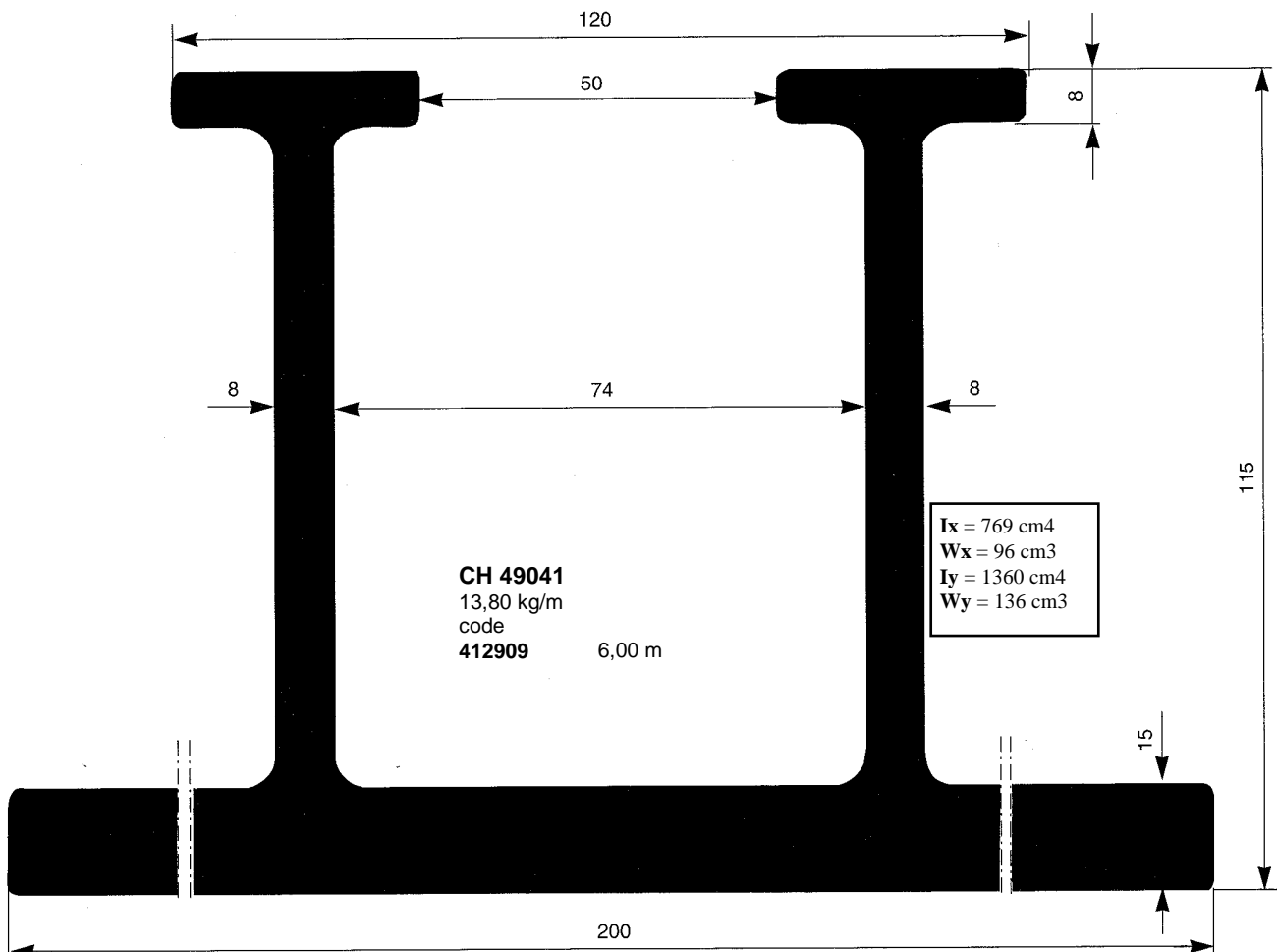
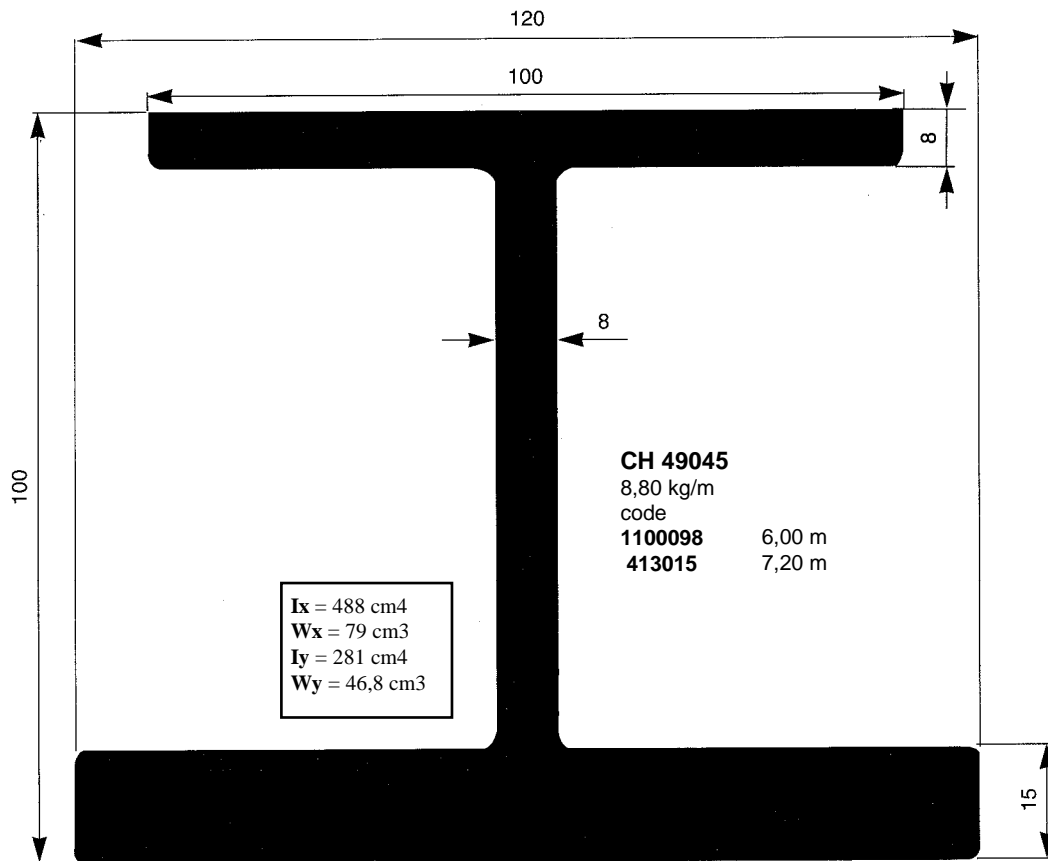

Kipper
Benne lisse
Kippermulden

30mm

F-3-10

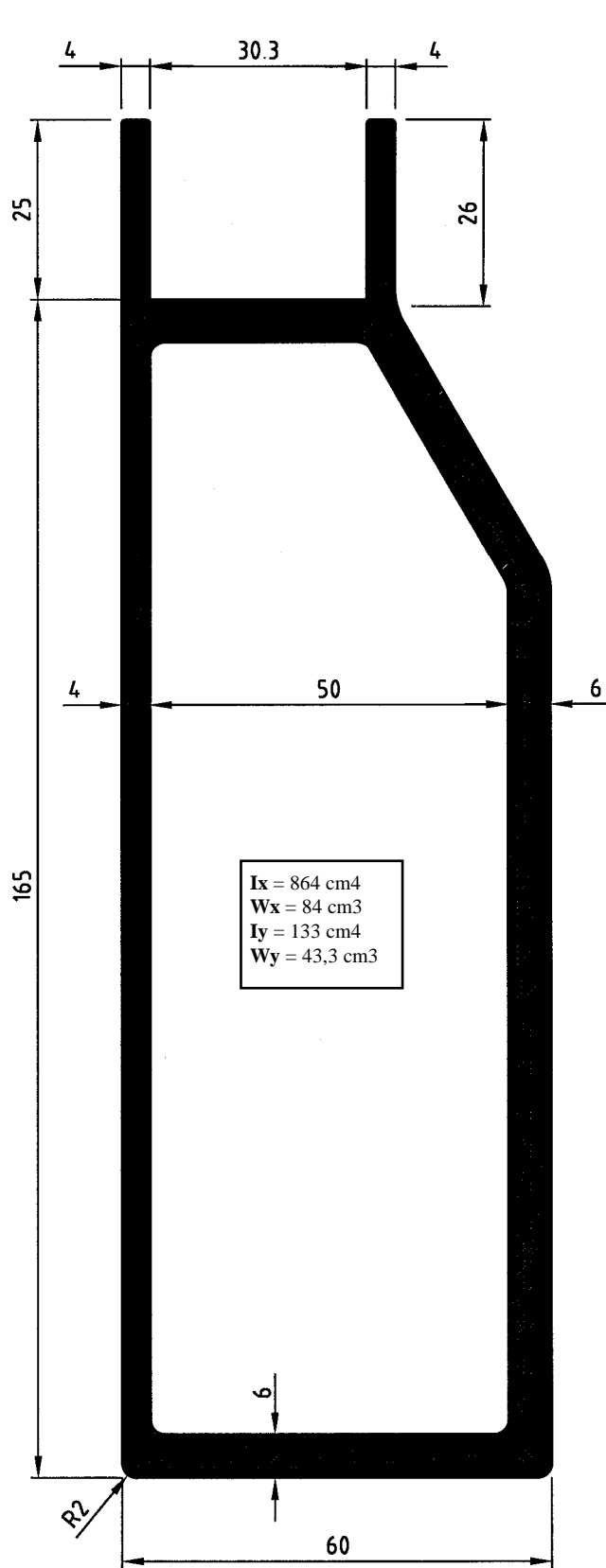

FL 25463
 6,37 kg/m
 code
 417717 7,50 m

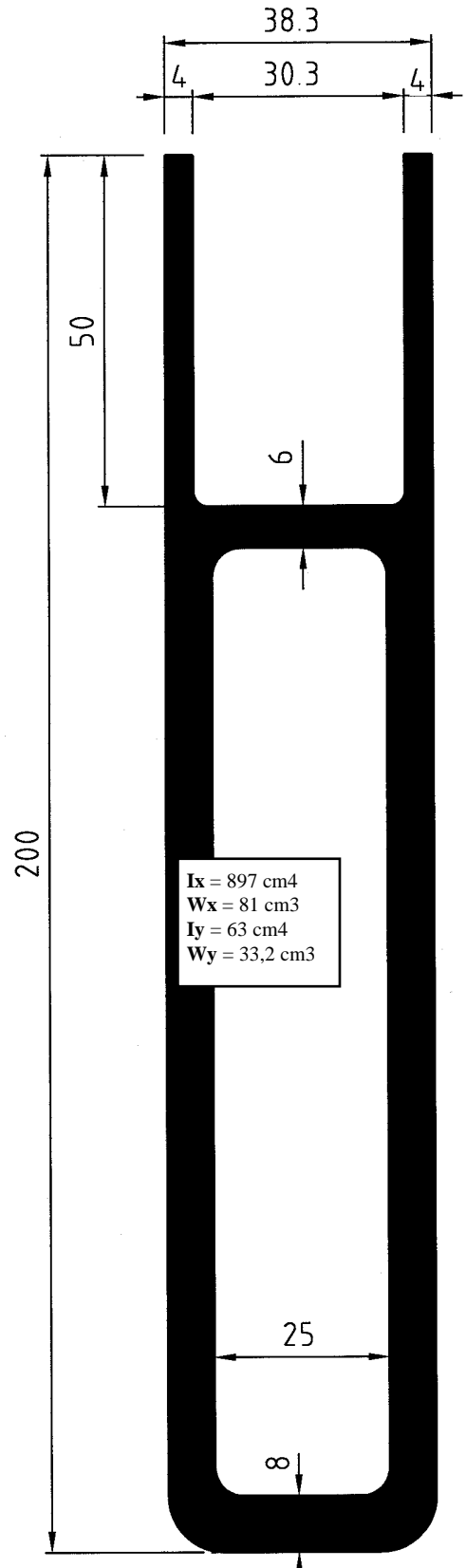

FL 27628
 7,51 kg/m
 code
 418617 7,50 m

Kipper
Benne lisse
Kippermulden

30mm

F-3-11

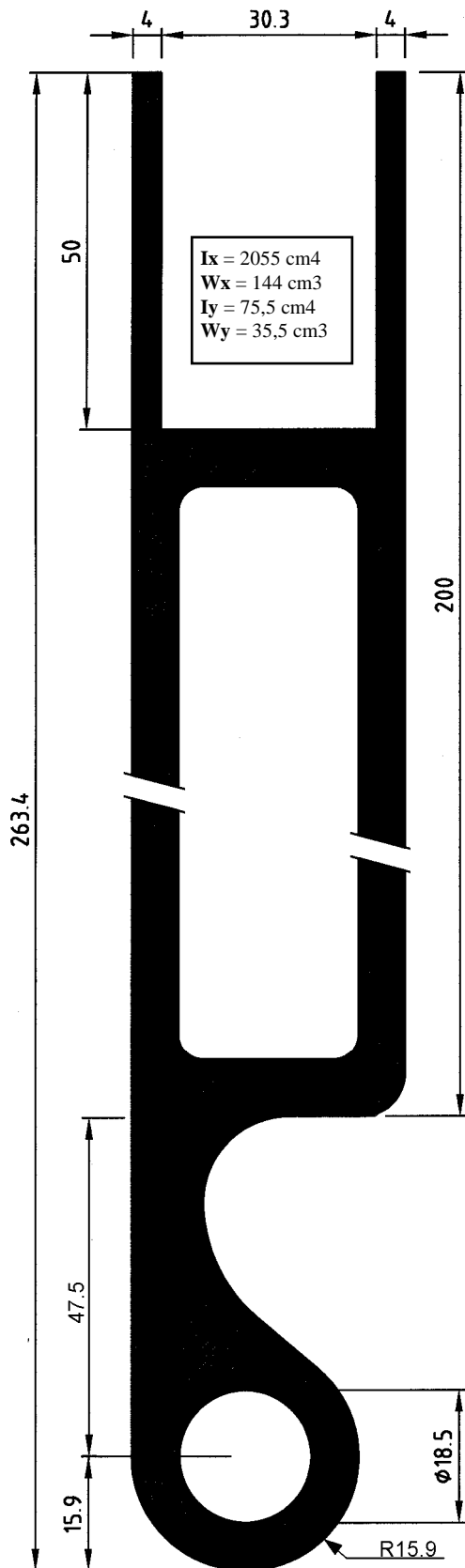

FL 26481
10,09 kg/m
code
418317 7,50 m

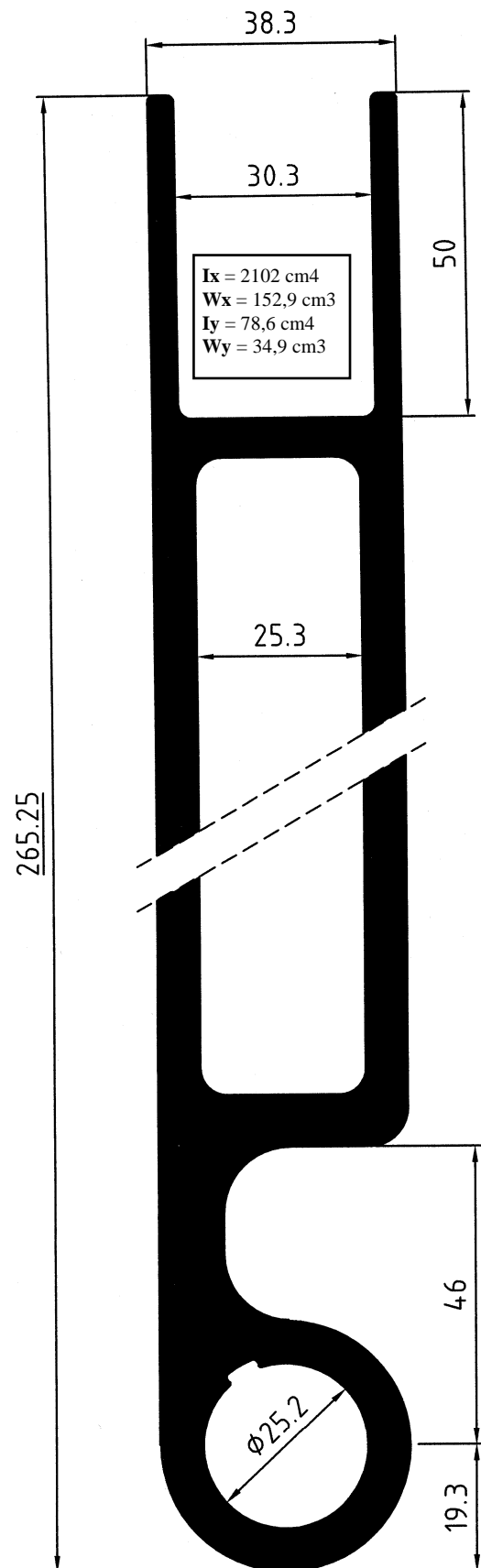

FT 61974
10,56 kg/m
code
418917 7,50 m

**Kipper
Benne lisse
Kippermulden**

F-3-12

30mm

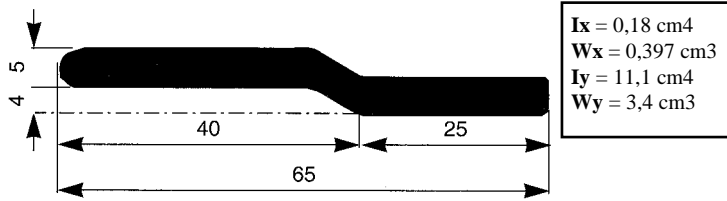

FL 07439
 0,89 kg/m
 code
416309 6,00 m



AN 587
 0,11 kg/m
 code
444031 40 m

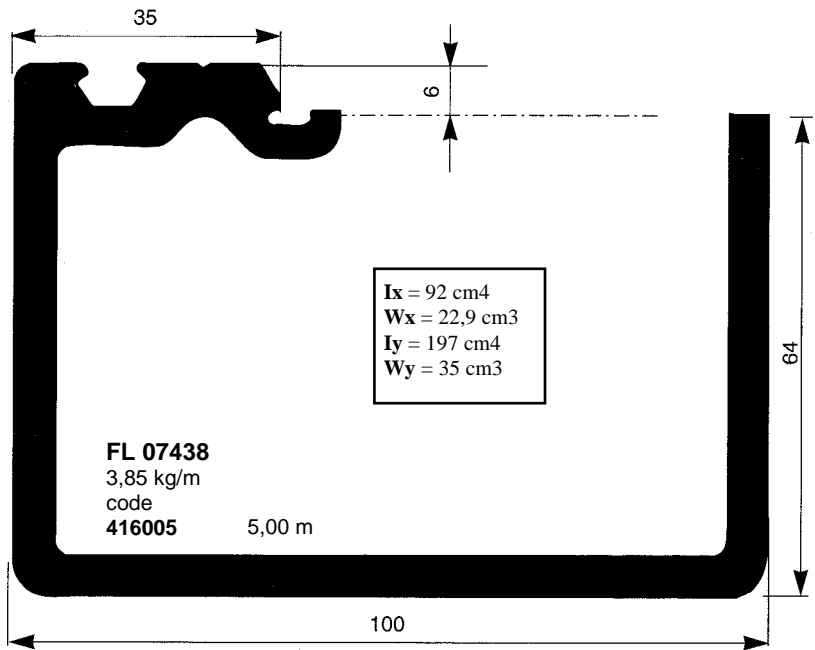

FL 07438
 3,85 kg/m
 code
416005 5,00 m

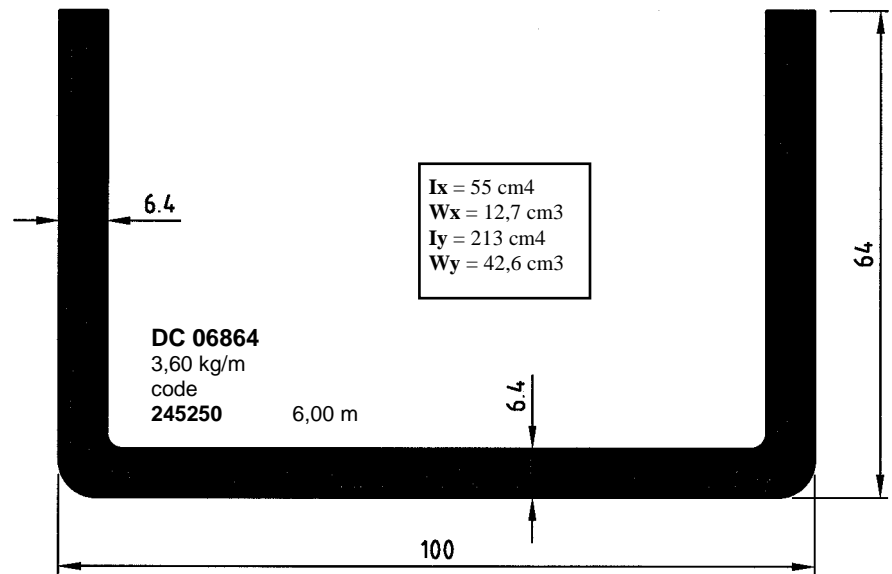

DC 06864
 3,60 kg/m
 code
245250 6,00 m

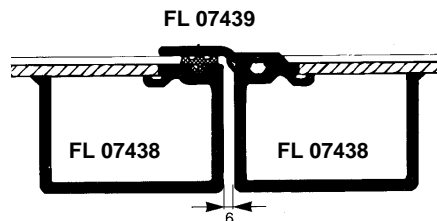
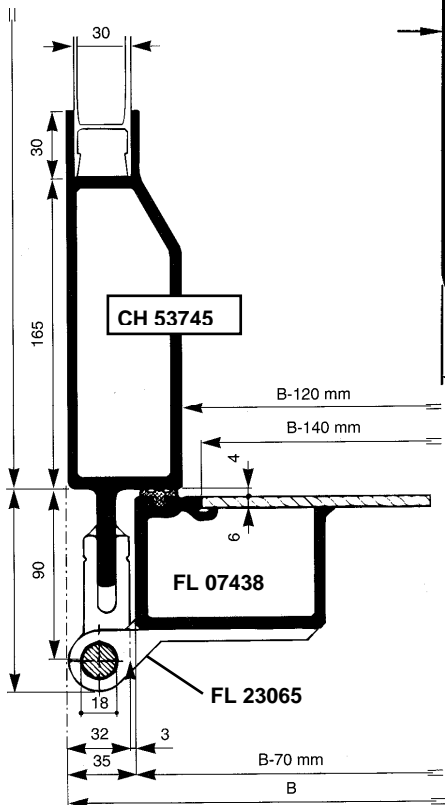

**Kipper
Benne lisse
Kippermulden**

30mm

F-3-13

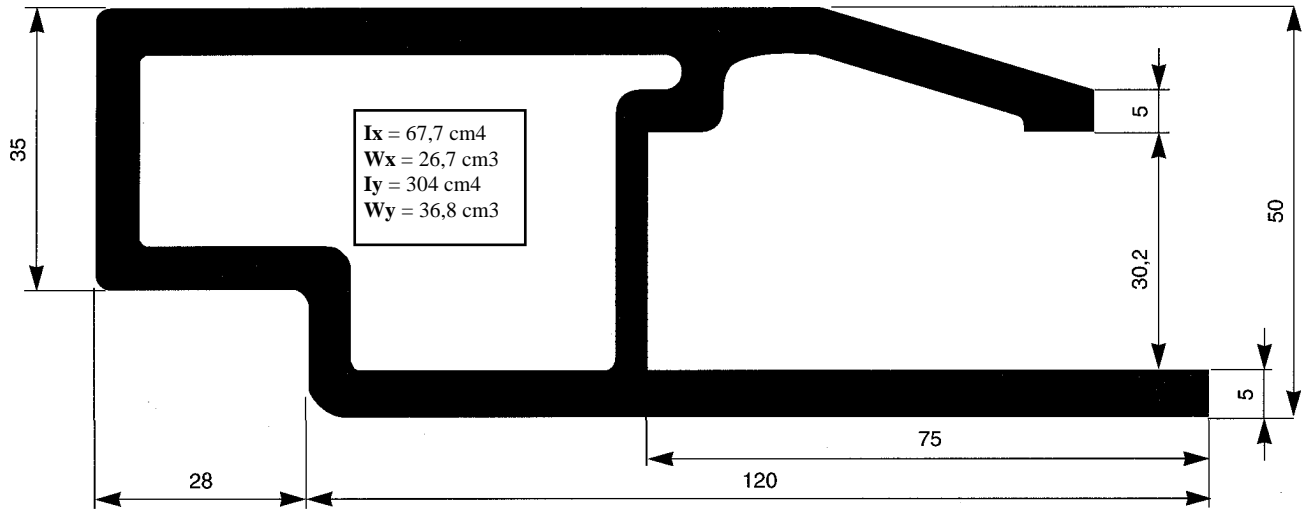

FL 25246
4,97 kg/m
code
415807

5,50 m

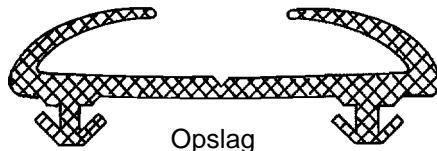

Opslag
Ouvert
Lagerung

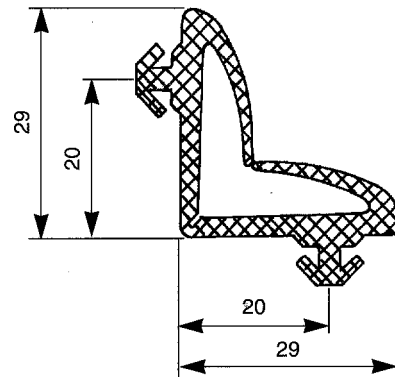

AN 736
0,38 kg/m
code
444090 30 m

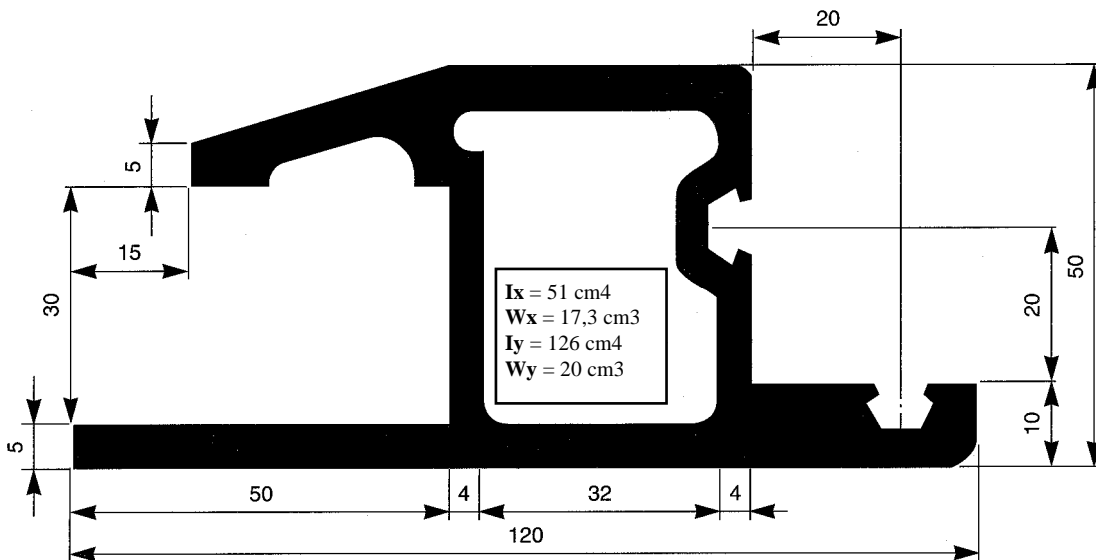

FL 25245
4,02 kg/m
code
1102543

5,60 m

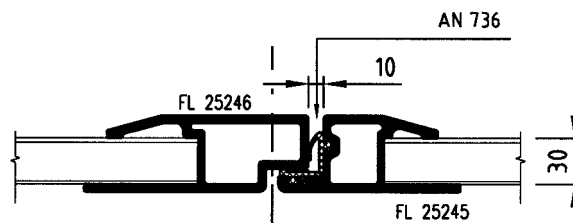

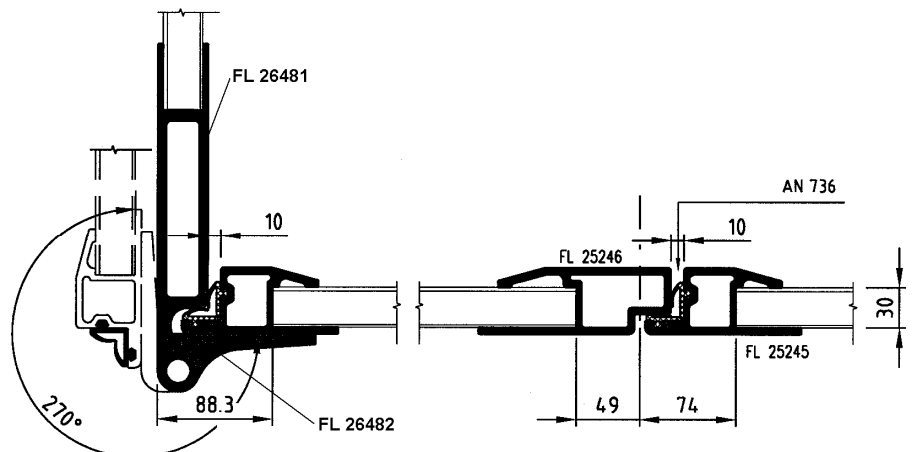
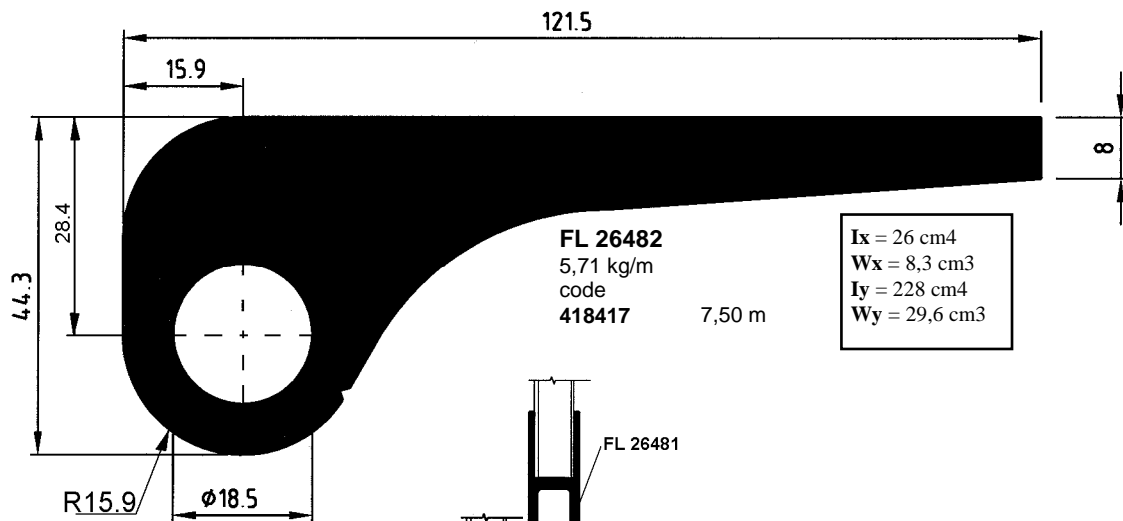
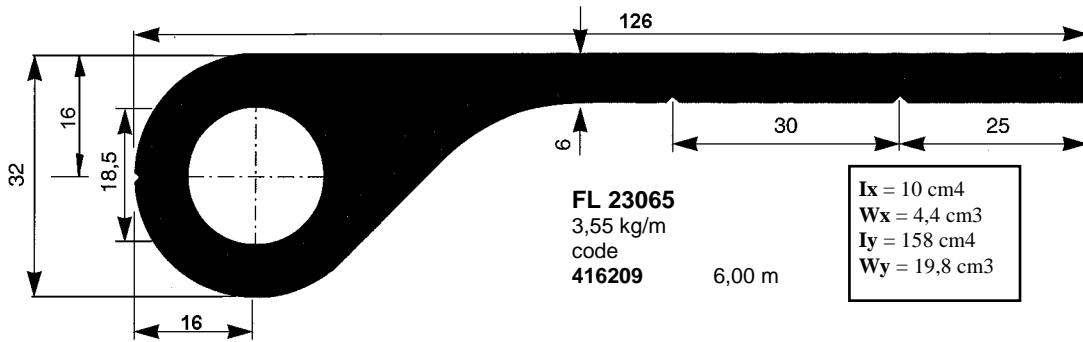
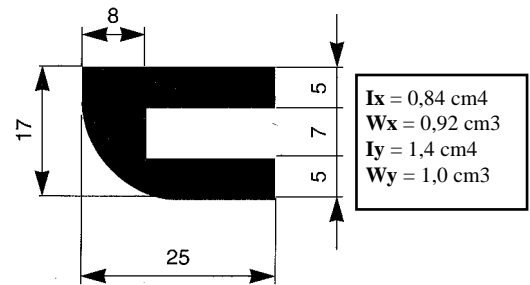
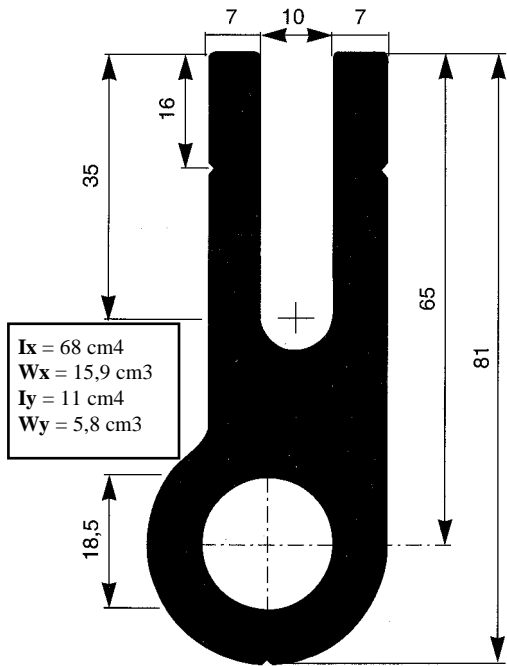

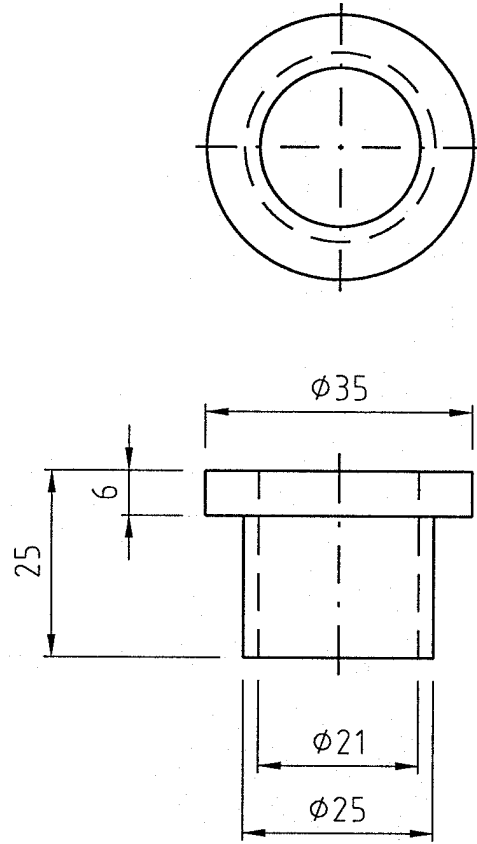
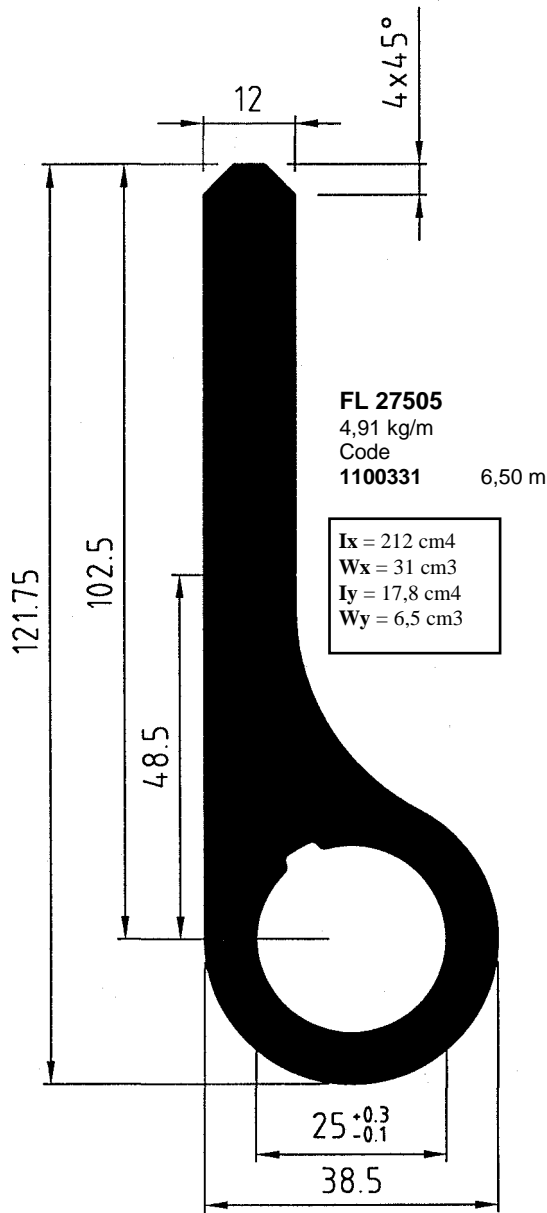

AN 771
0,01 kg/st-p
code
643320

Kunststof / Ertalon / Kunststoff

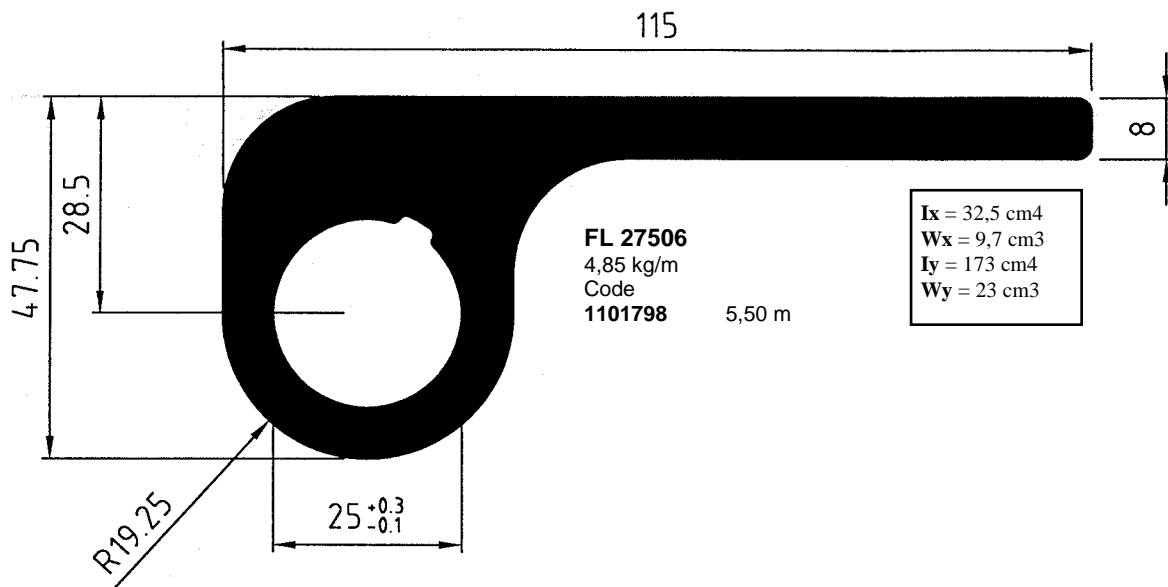

**Kipper
Benne lisse
Kippermulden**

F-4-1

50 mm

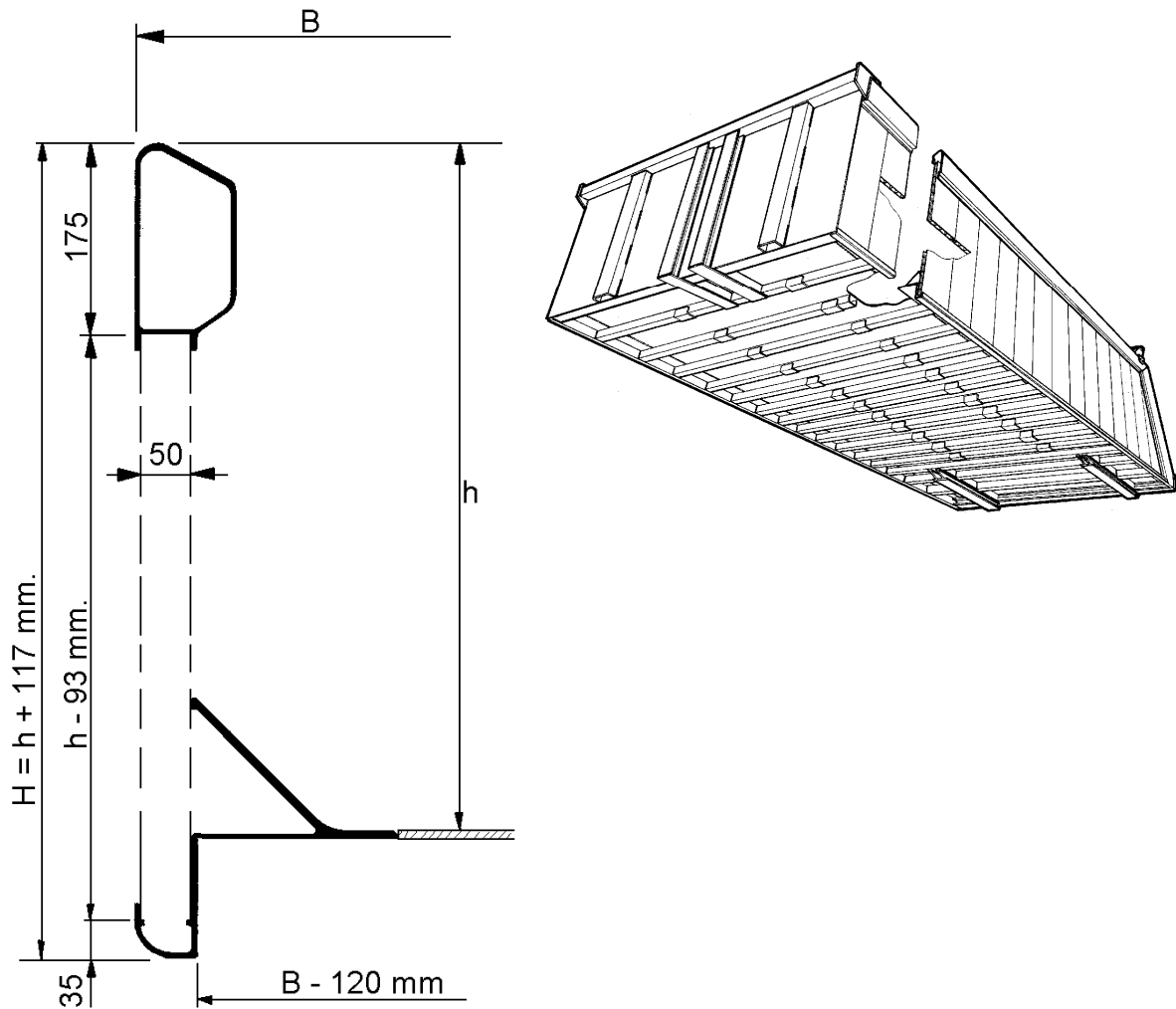









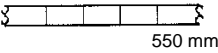

Platen	Tôles	Bleche				
Code	Dikte Epaisseur Dicke	Afmetingen Dimensions Abmessungen	Legering - Alliage - Legierung AlMg4,5Mn EN 5083 H 111		kg/st-p	kg/m ²
3044	4,0	2000 x 6000	Buigradius 2 * plaatdikte		130,80	10,90
3047	6,0	2000 x 6000	Bon pour le pliage		196,20	16,35
147280	8,0	2000 x 6000	R de pliage 2 * épaisseur		261,60	21,80
147210	10,0	2000 x 6000	Gut zum biegen		327,00	27,25
			Biegeradius 2 * Blechdicke			
			Legering - Alliage - Legierung		Vloerplaat	
1104206	6,0	2000 x 6000	Legierung		Tôle de fond	196,20 16,35
1104207	8,0	2000 x 6000	ENDUR-AL		Bodem Blech	261,60 21,80
			EN 5456 H 34			
			Legering - Alliage - Legierung		Vloerplaat	
142230	3,0	2000 x 6000	Legierung		Tôle de fond	98,10 8,18
142240	4,0	2000 x 6000	AlMg4,5Mn		Bodem Blech	130,80 10,90
142250	5,0	2000 x 6000	EN 5083 H 321			163,50 13,63
142555	5,0	2500 x 6000				204,38 13,63
142260	6,0	2000 x 6000				196,20 16,35
1104436	6,0	2500 x 6000				245,25 16,35
1104150	6,0	2400 x 7000				274,68 16,35
142270	7,0	2000 x 6000				228,90 19,08
142370	7,0	2400 x 6000				274,68 19,08
142280	8,0	2000 x 6000				261,60 21,80
142310	10,0	2000 x 6000				327,00 27,25

**Kipper
Benne lisse
Kippermulden**

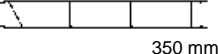
F-4-2

50 mm

Blz. Page Seite	Profiel nr. Nr. de profil Profil Nr.	Gewicht Poids Gewicht	Symbool Symbole Symbol	Beschrijving Description Bezeichnung	Lengte Longueur Länge
F-4-3	CH 55469	8,50 kg/m		Untergurtprofil Onderrandprofiel Rive inférieure	8,50 m 11,50 m
	CH 55467	4,90 kg/m		Hoekprofiel Profilé de coin Eckprofil	7,50 m
F-4-4	CH 55471	11,90 kg/m (21,64 kg/m ²)		Zijwandprofiel Profilé de paroi Wandprofil	5,50 m 6,60 m 7,20 m
	CH 55470	6,30 kg/m		Bovenrandprofiel Profilé supérieur Obergurtprofil	8,50 m 11,50 m
	AS 08392	0,03 kg/st-p		Klemveer Ressort de liaison Wendelfeder	
F-4-5	DC 10194	7,23 kg/m		Bovenrandprofiel Profilé supérieur Obergurtprofil	11,0 m
	FL 29294	7,20 kg/m (20,71 kg/m ²)		Zijwandprofiel Profilé de paroi Wandprofil	6,00 m 6,60 m
F-4-6	FL 07439	0,90 kg/m		Afsluitprofiel Profilé de battée Schlussprofil	6,00 m
	AN 587	0,11 kg/m		Afdichtrubber Joint Dichtung	40 m
	FL 07438	3,85 kg/m		Deurrandprofiel Rive de porte	5,00 m
	DC 06864	3,59 kg/m		Türgurtprofil	6,00 m

Kipper
Benne lisse
Kippermulden

50 mm

F-4-3

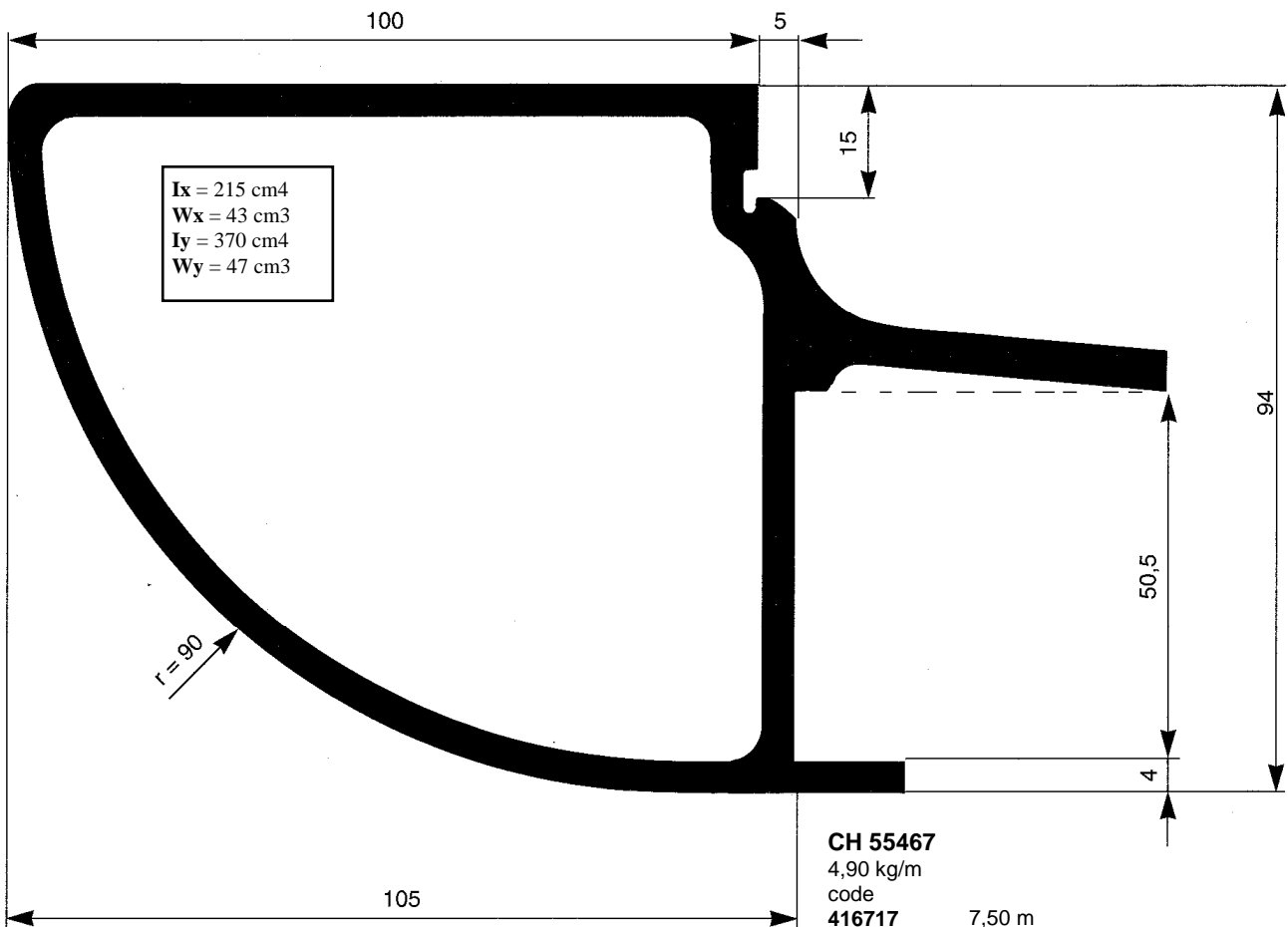
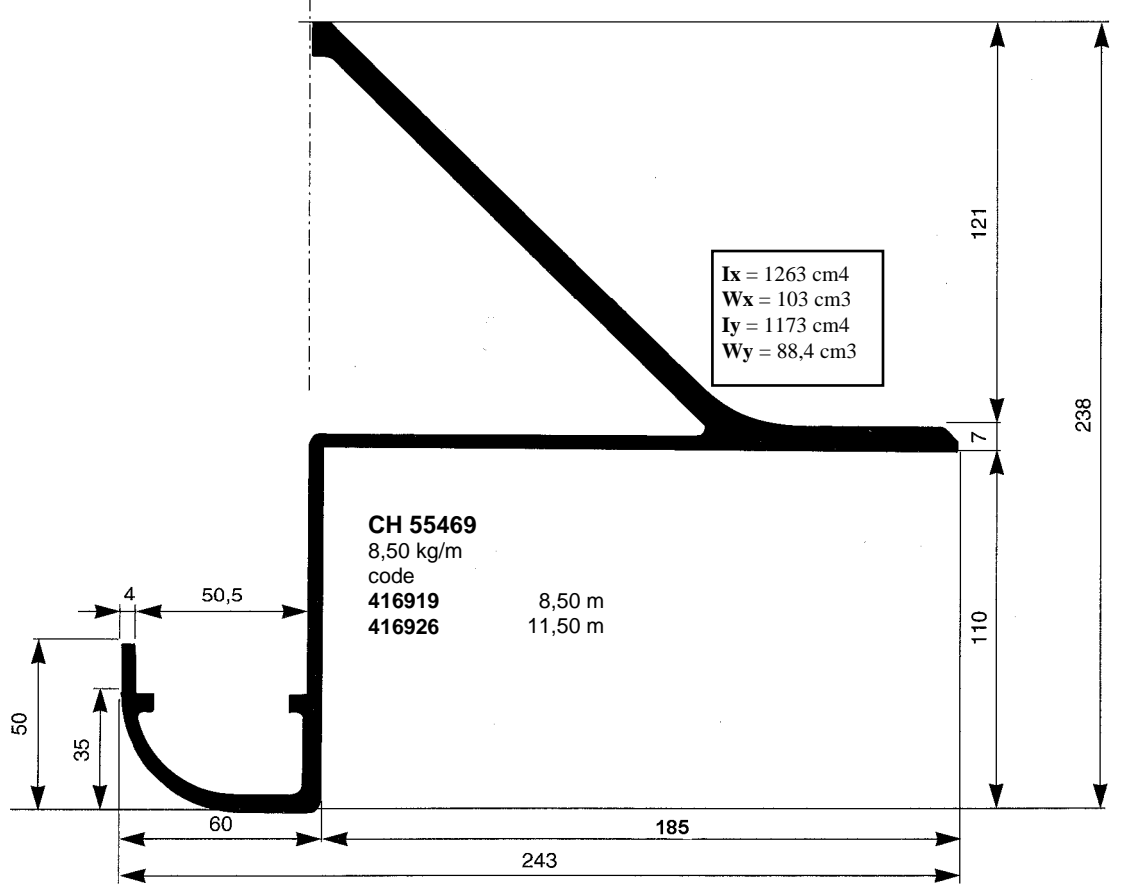

**Kipper
Benne lisse
Kippermulden**

F-4-4

50 mm

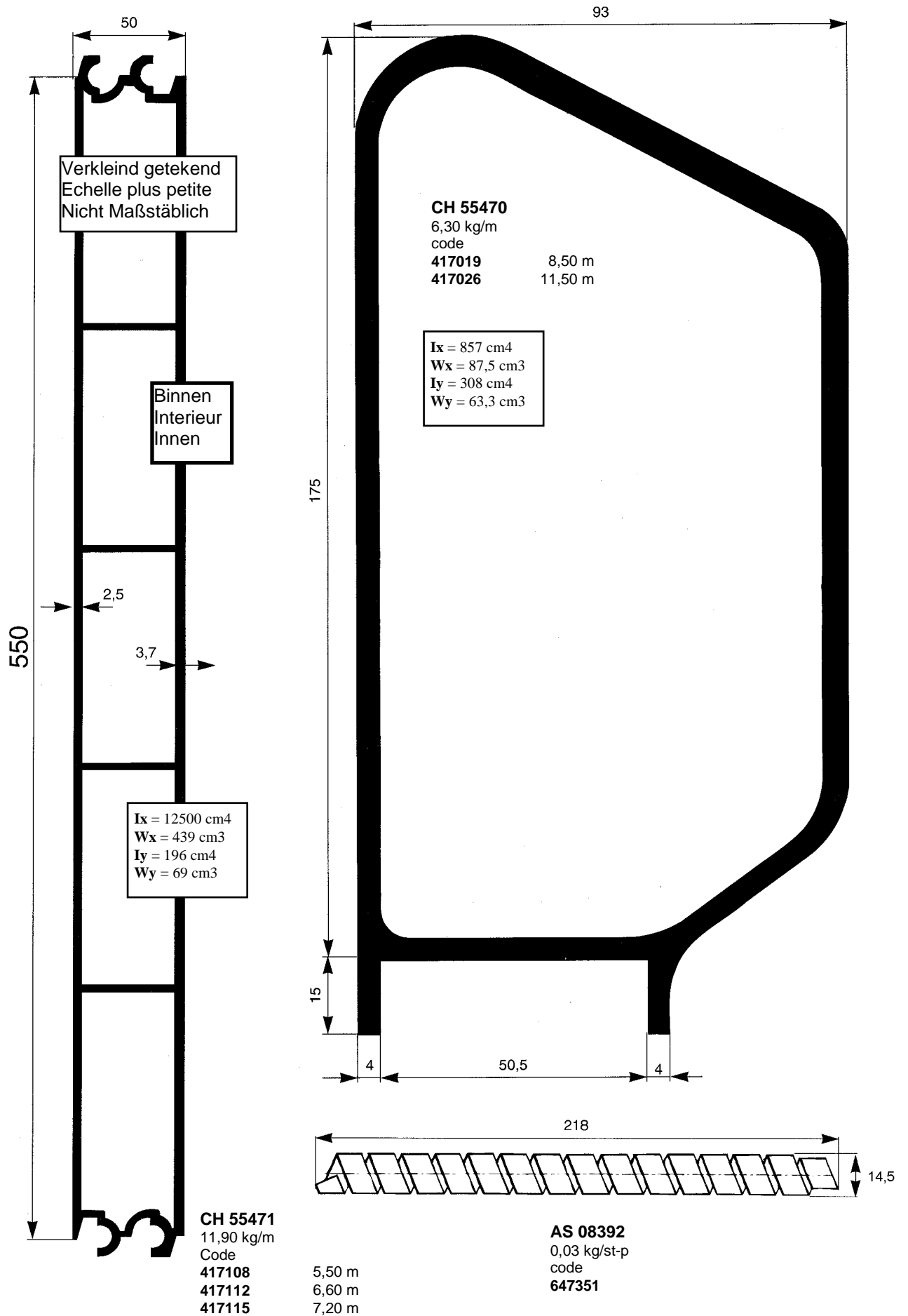

Kipper
Benne lisse
Kippermulden

50 mm

F-4-5

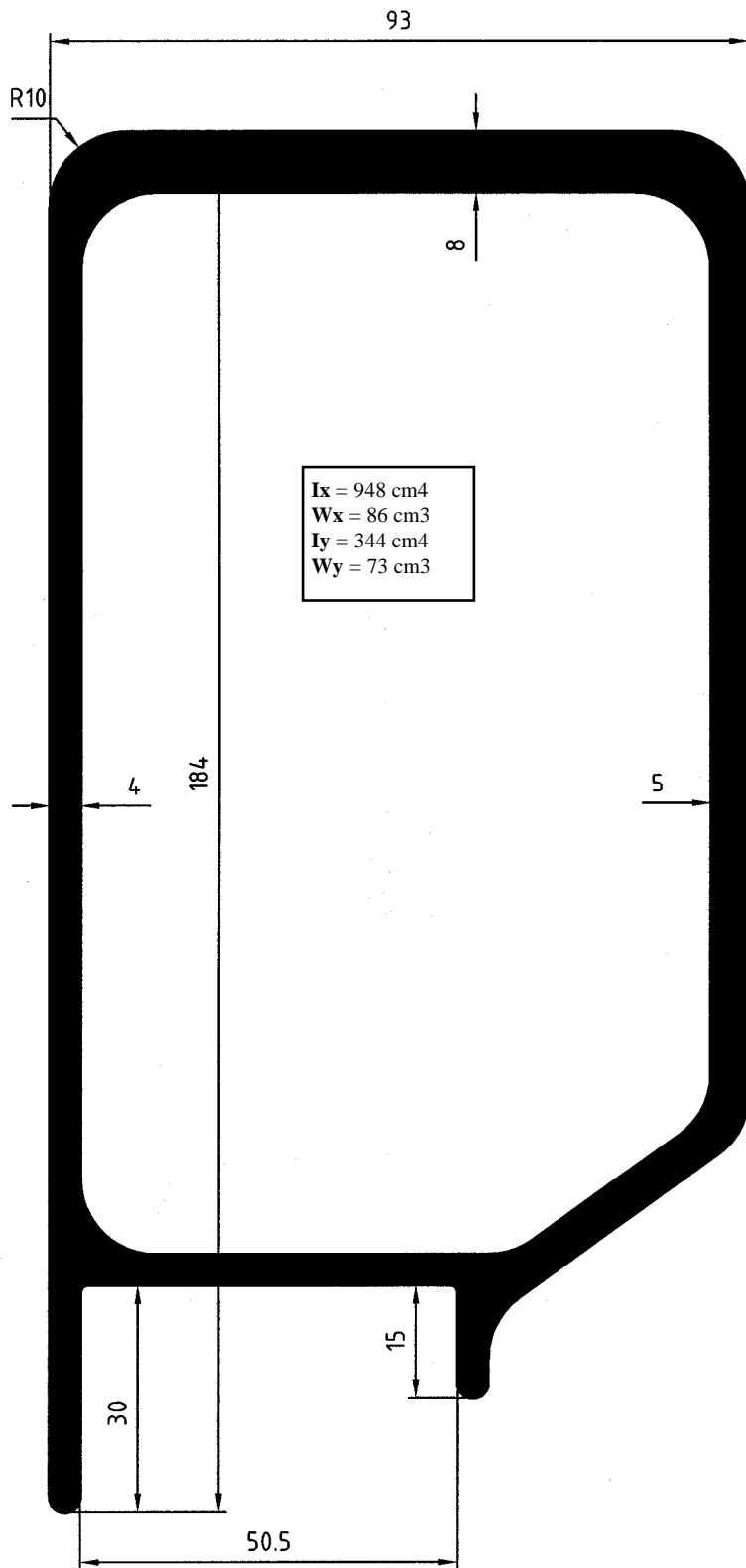

DC 10194
7,23 kg/m
code
1100200 11,00 m

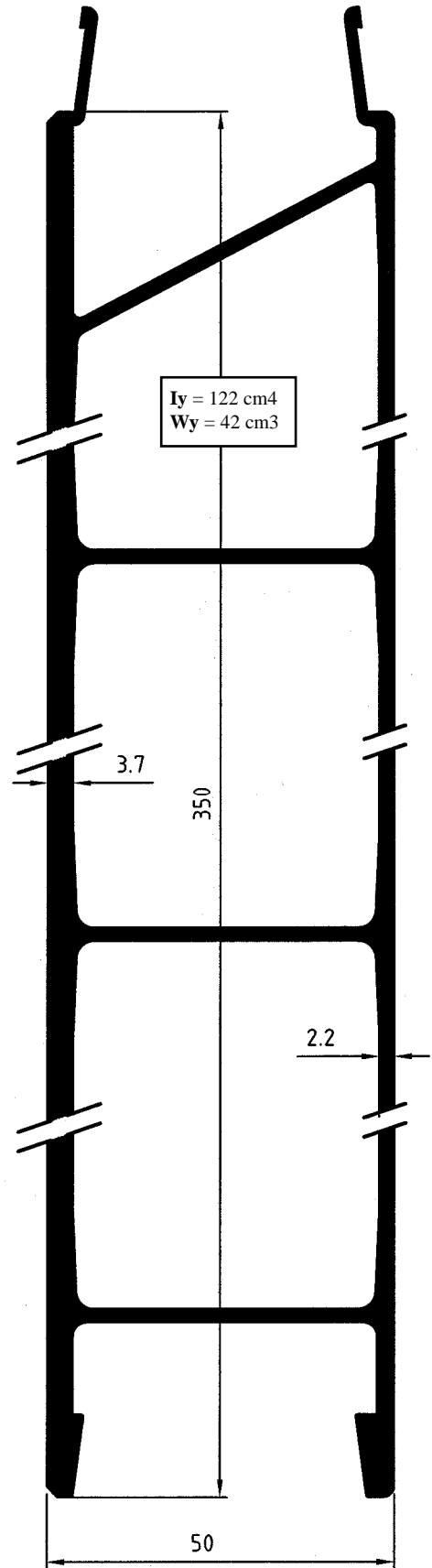

FL 29294
7,20 kg/m
code
1104864 6,00 m
1100150 6,60 m

**Kipper
Benne lisse
Kippermulden**

50mm

F-4-6

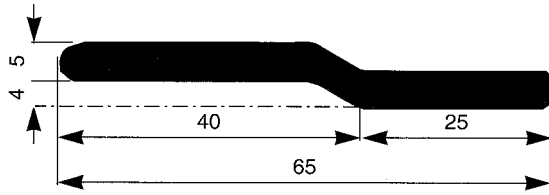

FL 07439
0,90 kg/m
code
416309 6,00 m



AN 587
0,11 kg/m
code
444031 40 m

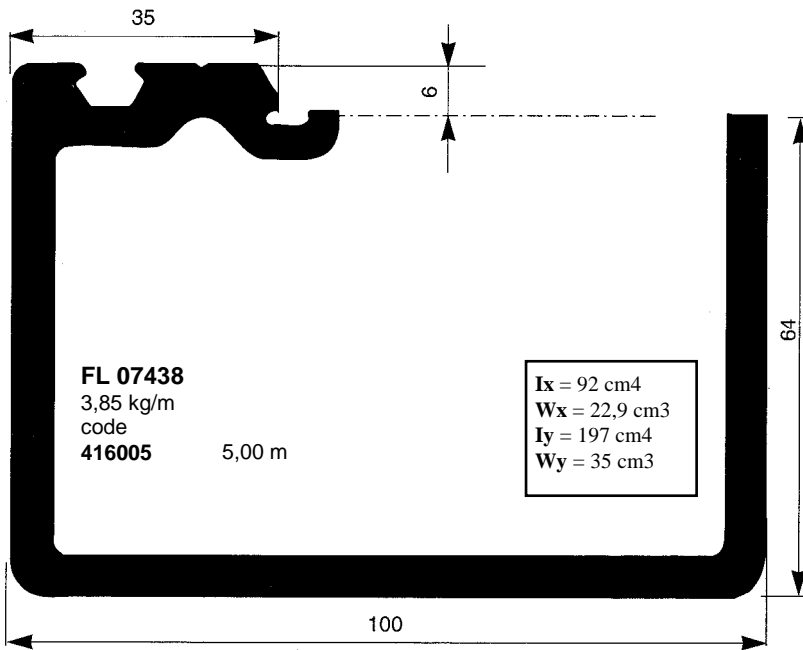

FL 07438
3,85 kg/m
code
416005 5,00 m

I_x = 92 cm⁴
W_x = 22,9 cm³
I_y = 197 cm⁴
W_y = 35 cm³

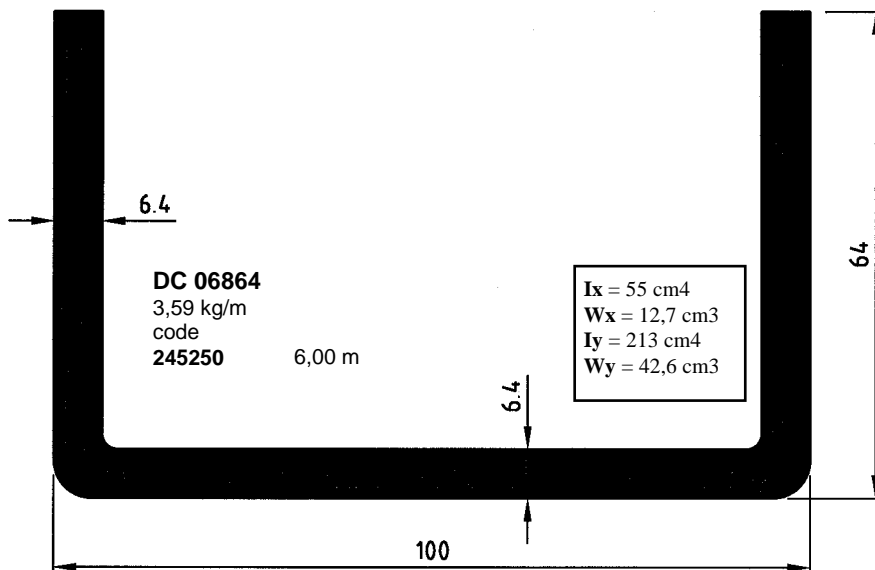

DC 06864
3,59 kg/m
code
245250 6,00 m

I_x = 55 cm⁴
W_x = 12,7 cm³
I_y = 213 cm⁴
W_y = 42,6 cm³

Kipper (plaatkonstructie)

Benne tôle

Kippermulden

F-5-1

Blz. Page Seite	Profiel nr. Nr. de profil Profil Nr.	Gewicht Poids Gewicht	Symbol Symbole Symbol	Beschrijving Description Bezeichnung	Lengte Longueur Länge
F-5-2	CH 39233	7,86 kg/m		Bovenrandprofiel Profilé supérieur Untergurtprofil	10,00 m
F-5-3	FL 06008	3,40 kg/m		Dwarsligger Traverse Querträger	5,00 m
	FL 08098	4,10 kg/m			5,05 m
F-5-4	CH49043	4,80 kg/m			5,05 m
	DC 07334	6,51 kg/m			5,00 m 6,00 m
	AL 03607	0,32 kg/m		Profiel voor afdichtrubber Support de joint Dichtungshalter	6,00 m
	CVT4030090	0,42 kg/m		Dichtung	30 m

Platen	Tôles	Bleche			
Code	Dikte Epaisseur Dicke	Afmetingen Dimensions Abmessungen	Legering - Alliage - Legierung AlMg4,5Mn EN 5083 H 111	kg/st-p	kg/m ²
			Buigradius 2 * plaatdikte Bon pour le pliage		
3044	4,0	2000 x 6000		130,80	10,90
3047	6,0	2000 x 6000	R de pliage 2 * épaisseur	196,20	16,35
147280	8,0	2000 x 6000	Gut zum biegen	261,60	21,80
147210	10,0	2000 x 6000	Biegeradius 2 * Blechdicke	327,00	27,25
			Legering - Alliage - Legierung		
1104206	6,0	2000 x 6000	ENDUR-AL	Vloerplaat Tôle de fond Bodem Blech	196,20 16,35
1104207	8,0	2000 x 6000	EN 5456 H 34		261,60 21,80
			Legering - Alliage - Legierung		
142230	3,0	2000 x 6000	AlMg4,5Mn	Vloerplaat Tôle de fond Bodem Blech	98,10 8,18
142240	4,0	2000 x 6000	EN 5083 H 321		130,80 10,90
142250	5,0	2000 x 6000			163,50 13,63
142555	5,0	2500 x 6000			204,38 13,63
142260	6,0	2000 x 6000			196,20 16,35
1104436	6,0	2500 x 6000			245,25 16,35
1104150	6,0	2400 x 7000			274,68 16,35
142270	7,0	2000 x 6000			228,90 19,08
142370	7,0	2400 x 6000			274,68 19,08
142280	8,0	2000 x 6000			261,60 21,80
142310	10,0	2000 x 6000			327,00 27,25

Kipper (plaatkonstruktie)
Benne tôlée
Kippermulden

F-5-2

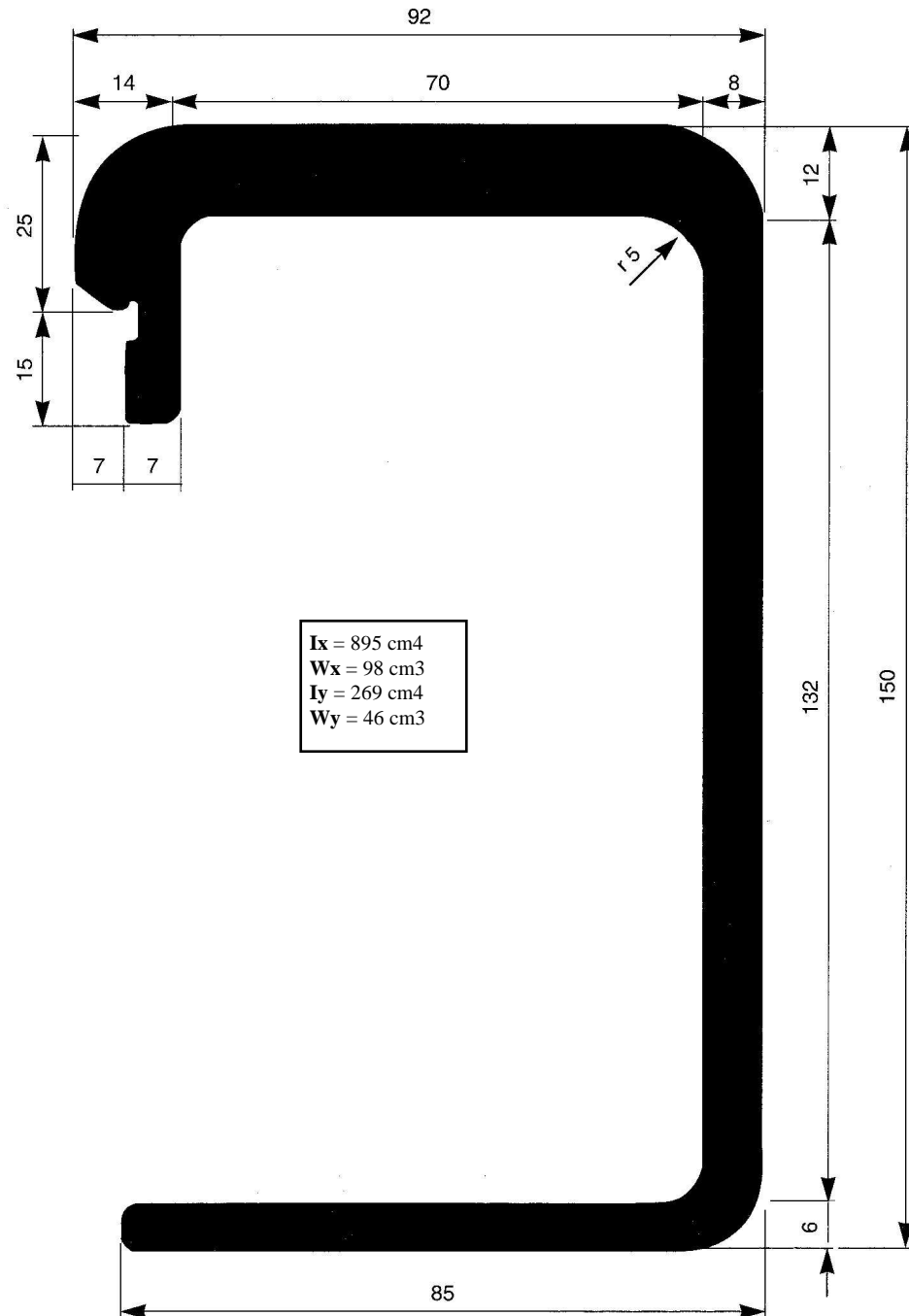

CH 39233
7,86 kg/m
code
411421 10,00 m

Kipper (plaatkonstruktie)
Benne tôlée
Kippermulden

F-5-3

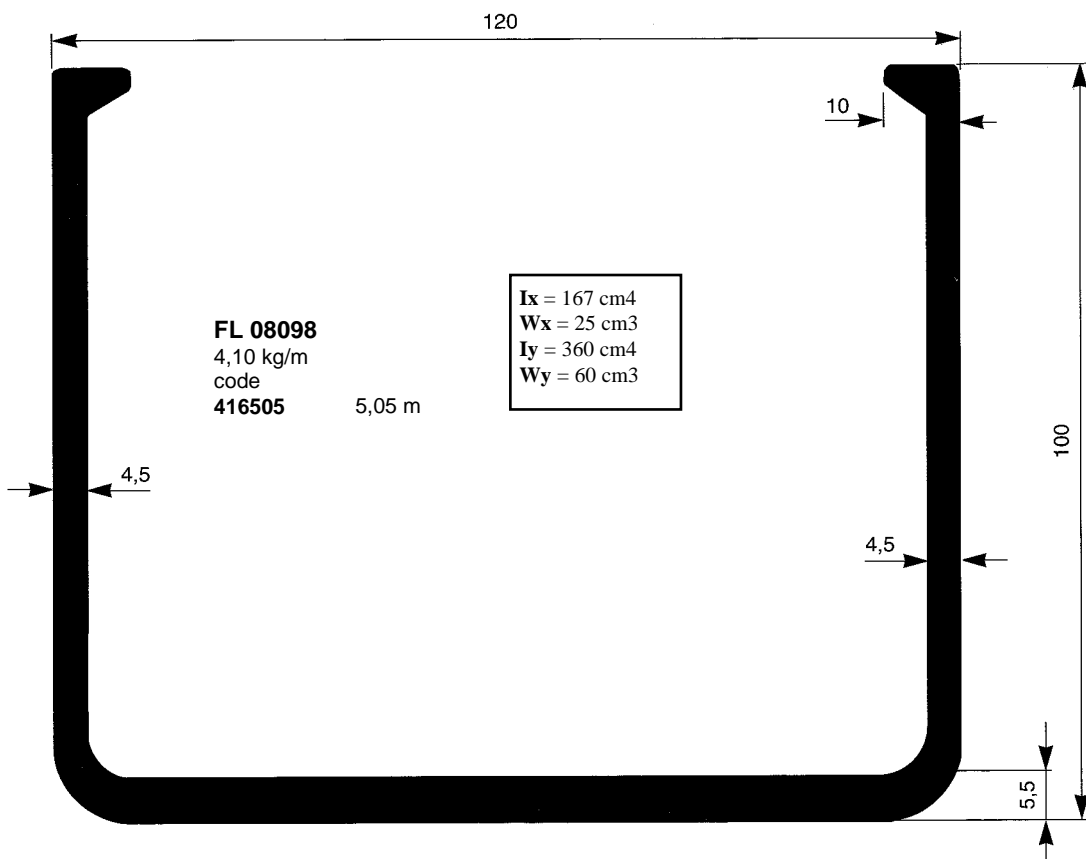
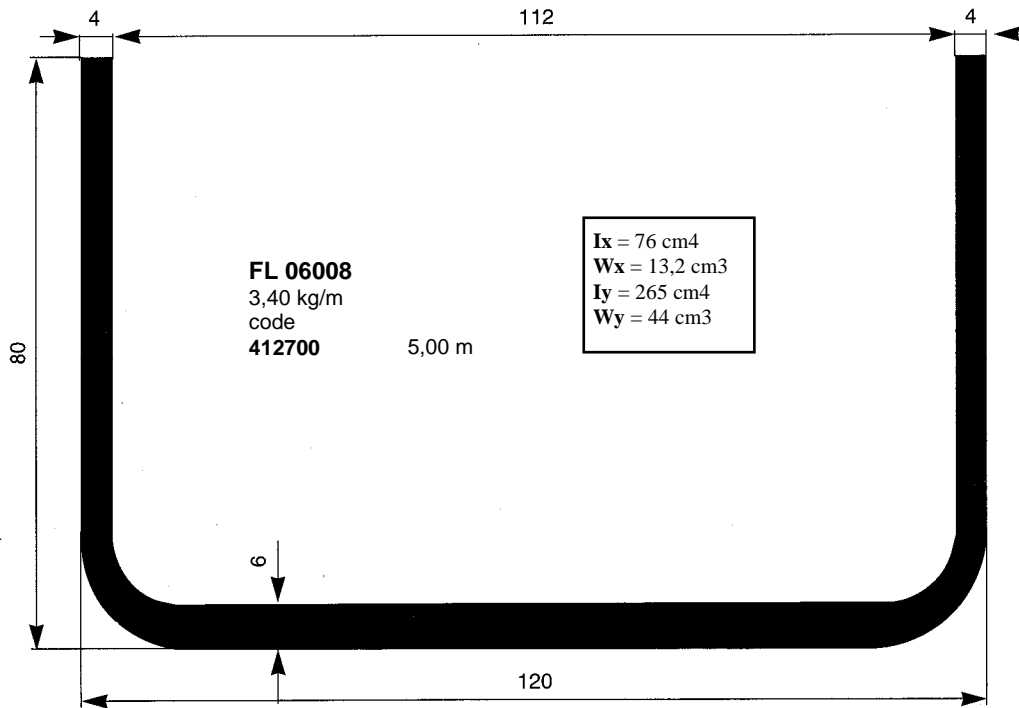

Kipper (plaatkonstruktie)
Benne tôle
Kippermulden

F-5-4

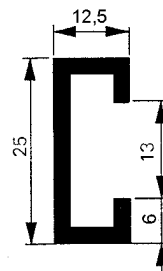
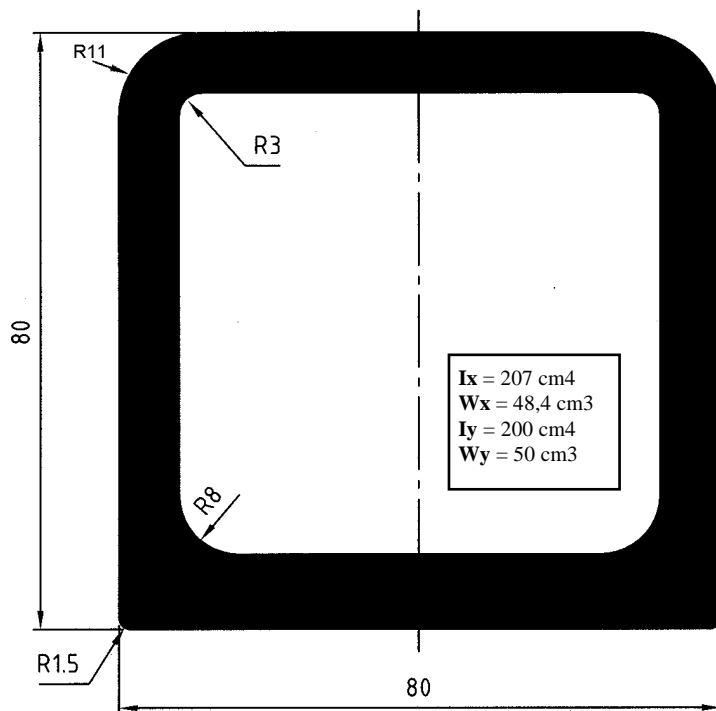
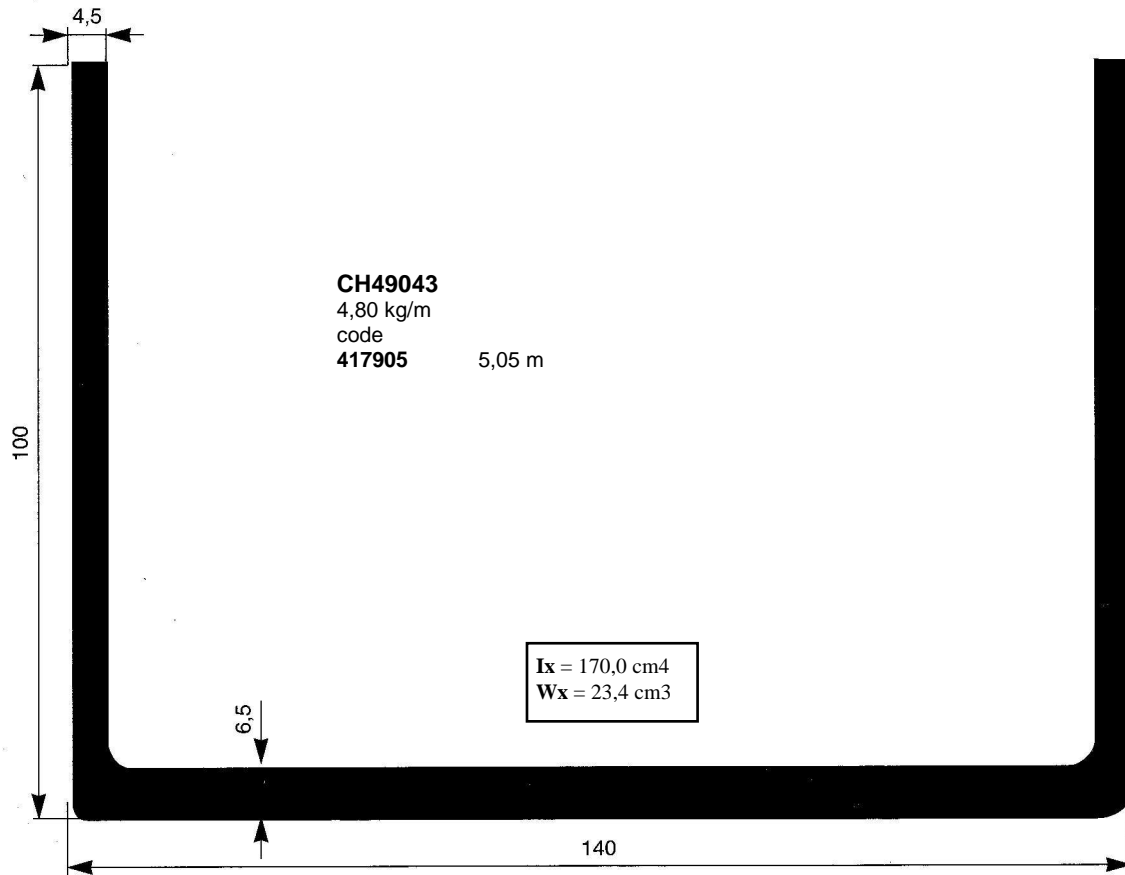

AL 03607
 0,32 kg/m
 code
417617 6,00 m

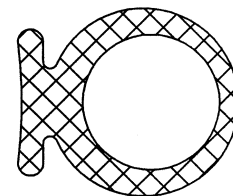

CVT4030090
 0,42 kg/m
 code
440810 30 m