

UNILOCK



*Ook zijn compleet
samengestelde zijborden
leverbaar op aanvraag.*

*Nous livrons des ridelles
montées avec un délai court.*

*Auch sind komplett montierte
Bordwände lieferbar nach
Kundenwunsch.*

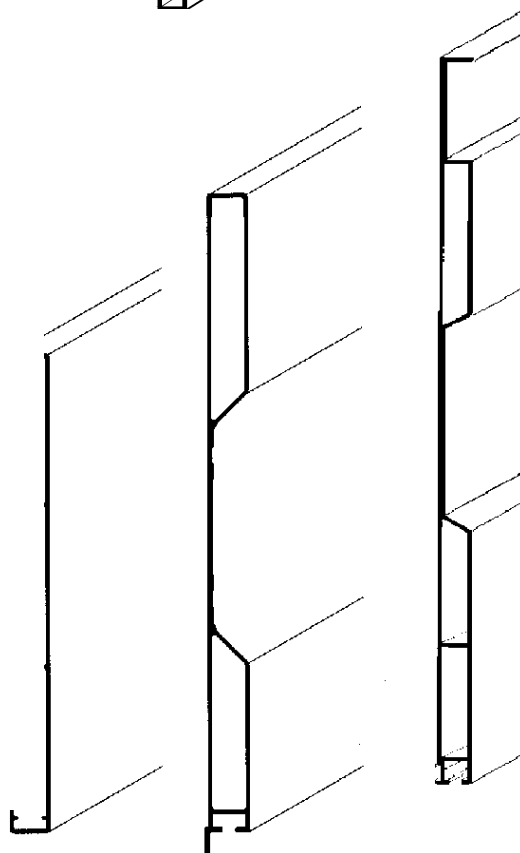

*Toebehoren zijbord
Accessoires de ridelle
Zubehör Bordwand
Blz. / page / Seite T*

Zijrandprofiel zijborden
 Embout de ridelle
 Einfaßprofile Bordwände

25 mm

A-0-1

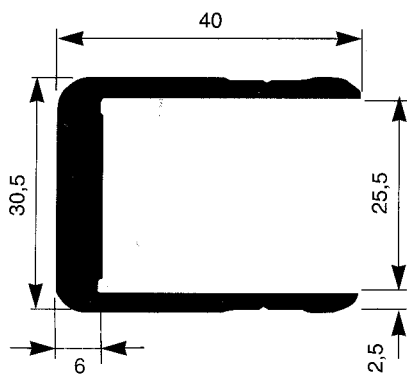

FL 04147

0,89 kg/m

code

350115 7,20 m Anod.

360115 7,20 m

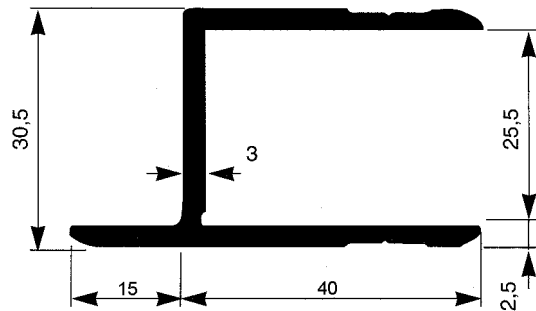

FL 06617

0,78 kg/m

code

350215 7,20 m Anod.

360215 7,20 m

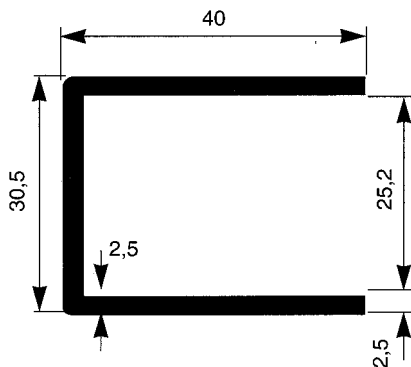

FL 02241

0,71 kg/m

code

511109 6,00 m Anod.

521109 6,00 m

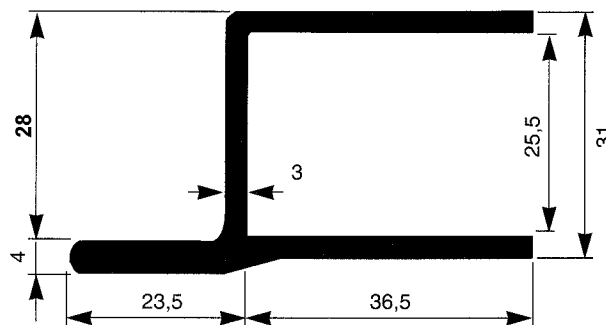

FL 02240

1,04 kg/m

code

510209 6,00 m Anod.

520209 6,00 m

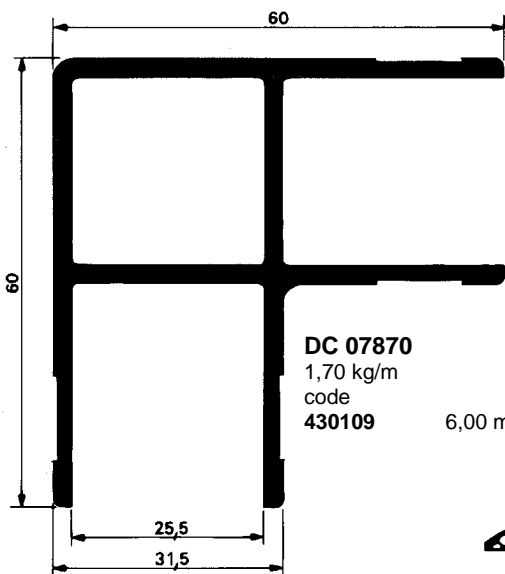

DC 07870

1,70 kg/m

code

430109 6,00 m

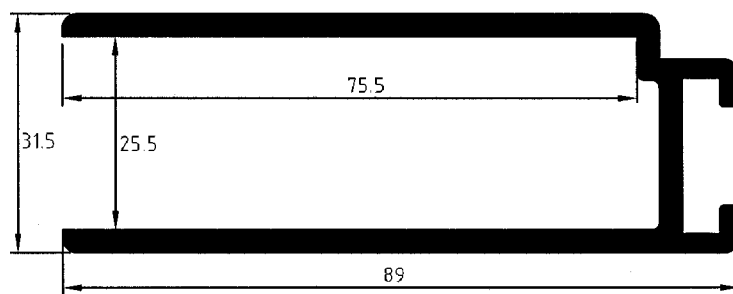

DC 08220

1,67 kg/m

*

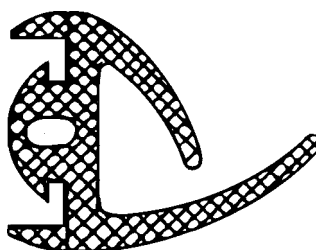

AN 575

0,56 kg/m

code

444055 6,50 m

Zijrandprofiel zijborden
 Embout de ridelle 25 mm Kinnegrip
 Einfaßprofile Bordwände

A-0-2

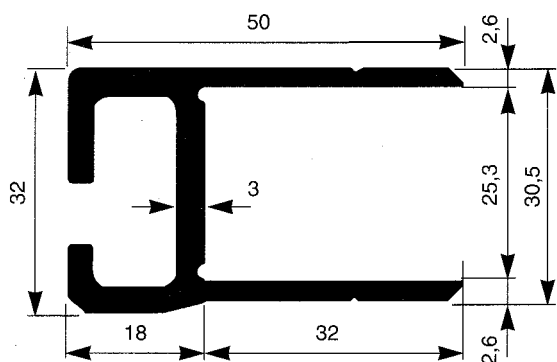

FL 07115

1,10 kg/m
code

353015 7,20 m Anod.
363015 7,20 m

KINNEGRIP IV

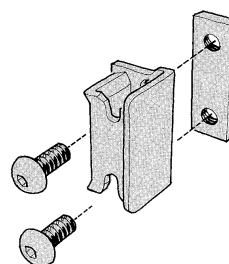

K-30023

0,21 kg/st-p
code
441013

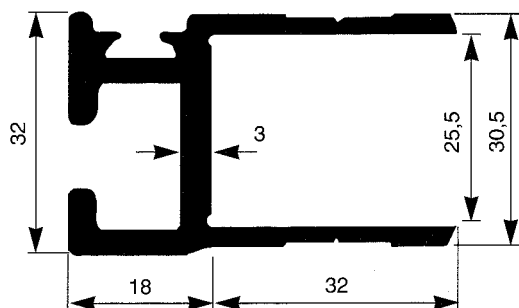
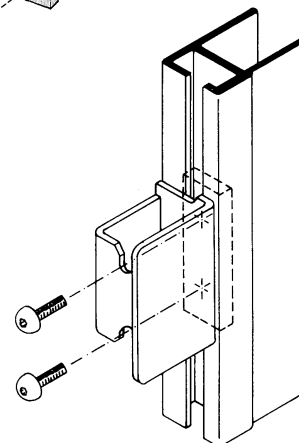

FL 08268

1,11 kg/m
code

353515 7,20 m Anod.
363515 7,20 m



AG 1332

0,05 kg/m
code
445020

100 m

KINNEGRIP K20

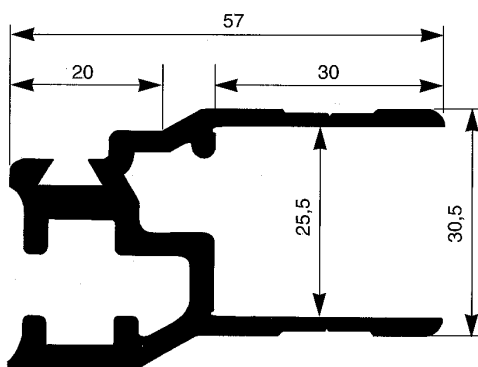

FL 10451

1,30 kg/m
code

353315 7,20 m Anod.
353309 6,00 m Anod.
363309 6,00 m

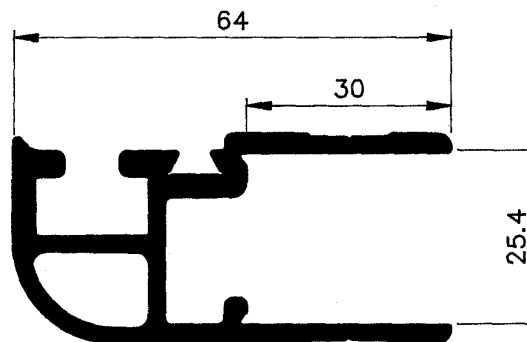

K 23239 / DC 07271

3,75 kg / st
code
952300

3,00 m Anod.

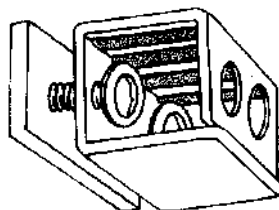





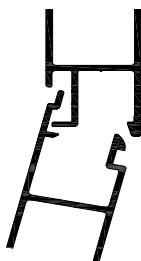
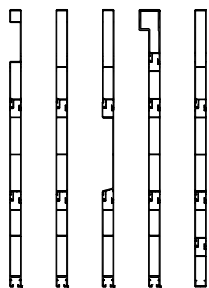



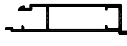
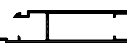
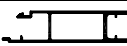
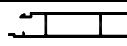
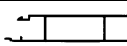
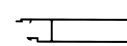

K-12161

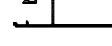
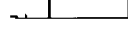
0,15 kg/st-p
code
952004

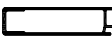

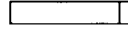
*In blank of geanodiseerde uitvoering
En brut ou anodisé
In Roh und Eloxierte Ausführung*

	Profiel nr. Nr. de profil Profil Nr.	Gewicht Poids Gewicht	Symbol Symbole Symbol	Beschrijving Description Bezeichnung	Lengte Longueur Länge
A-1-2	FT61330	1,37 kg/m	 100 mm	Onderrandprofiel Profilé inférieur Unteres Randprofil	7,60 m
	FT61331	1,28 kg/m	 100 mm		7,60 m
	FT61332	1,53 kg/m	 100 mm		7,60 m
	FT61333	2,58 kg/m	 200 mm		6,65 m 7,60 m
A-1-3	FT61796	2,49 kg/m	 200 mm	Onderrandprofiel	7,60 m
	DC07554	2,59 kg/m	 200 mm	Profilé inférieur Unteres Randprofil	6,65 m 7,60 m
	AN 768	0,11 kg/m		Rubberprofiel Joint	
	AN 587	0,11 kg/m		Dichtgummi	
	FT61794	0,88 kg/m	 50 mm		7,60 m
A-1-4	FT60359	1,32 kg/m	 100 mm	Tussenprofiel Profilé intermédiaire Zwischenprofil	7,60 m
	FT60357	2,32 kg/m	 200 mm		6,65 m 7,60 m
	FP60358	1,94 kg/m	 200 mm	Tir-profiel Profilé TIR Planösenprofil	7,60 m
A-1-5	DC08240	1,70 kg/m	 100 mm	Bovenrandprofiel Profilé supérieur	7,60 m
	FT61327	2,74 kg/m	 100 mm		7,60 m
A-1-6	FT61329	2,45 kg/m	 200 mm	Oberes Randprofil	6,65 m 7,60 m
	FT61328	2,39 kg/m	 200 mm		7,60 m
	AN 677	0,002 kg/st-p		inslagdop grijs Couvercle gris Endkappe grau	

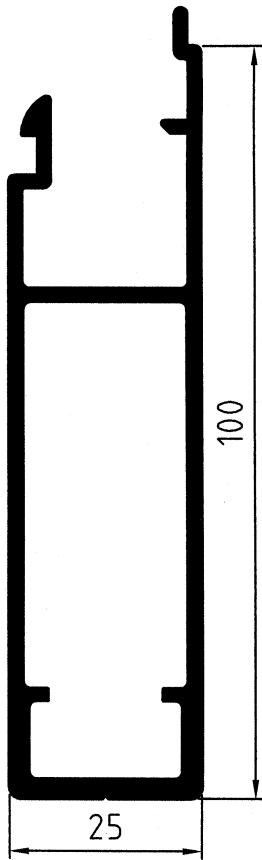

FT 61331

1,28 kg/m

code

322818

7,60 m

Anod.

522818

7,60 m

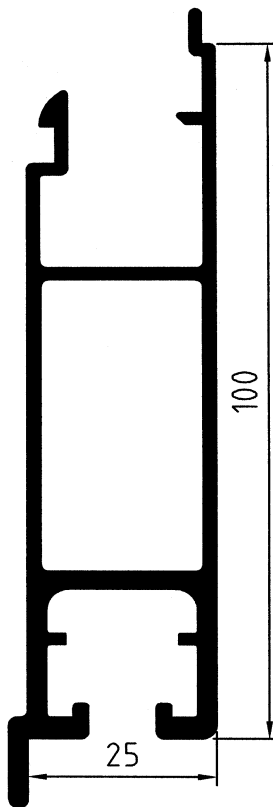

FT 61332

1,53 kg/m

code

321118

7,60 m

Anod.

521118

7,60 m

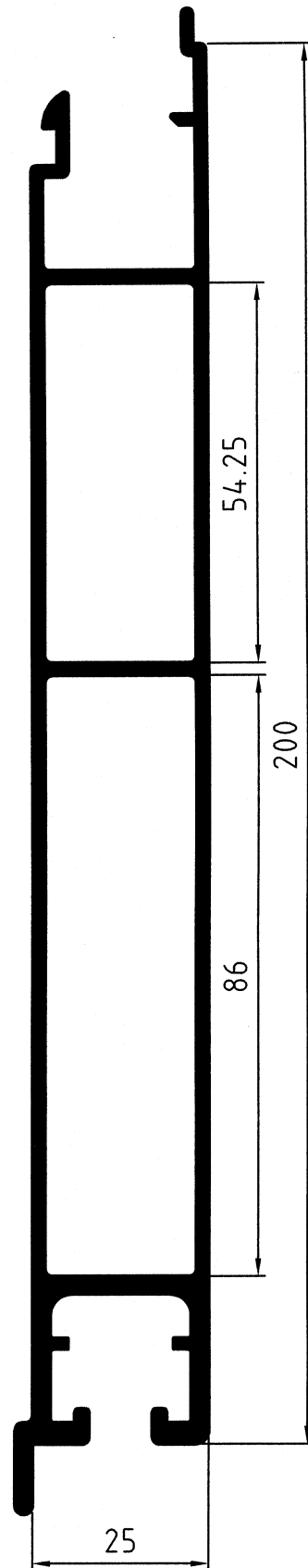

FT 61333

2,58 kg/m

code

321614

6,65 m

Anod.

321618

7,60 m

Anod.

521614

6,65 m

521618

7,60 m

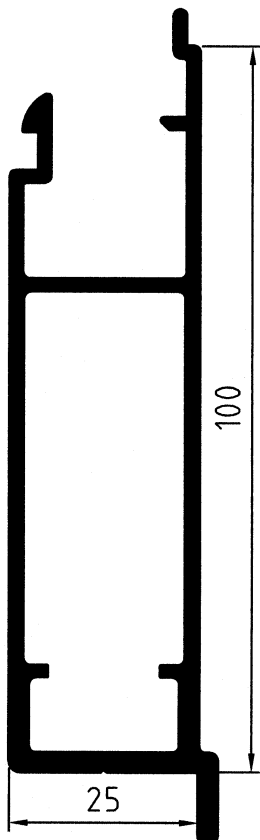

FT 61330

1,37 kg/m

code

321218

7,60 m

Anod.

521218

7,60 m

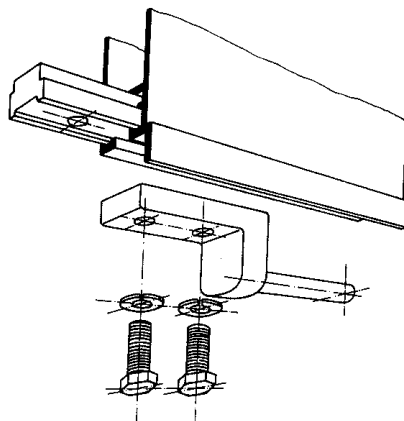

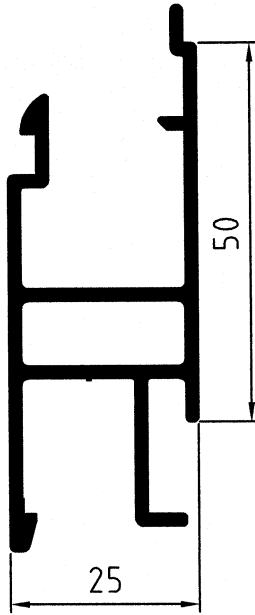

FT 61794
0,88 kg/m
code
320318 7,60 m Anod.
520318 7,60 m

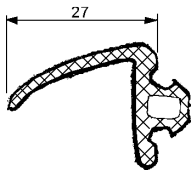

AN 768
0,11 kg/m
code
952012

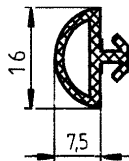

AN 587
0,11 kg/m
code
444031

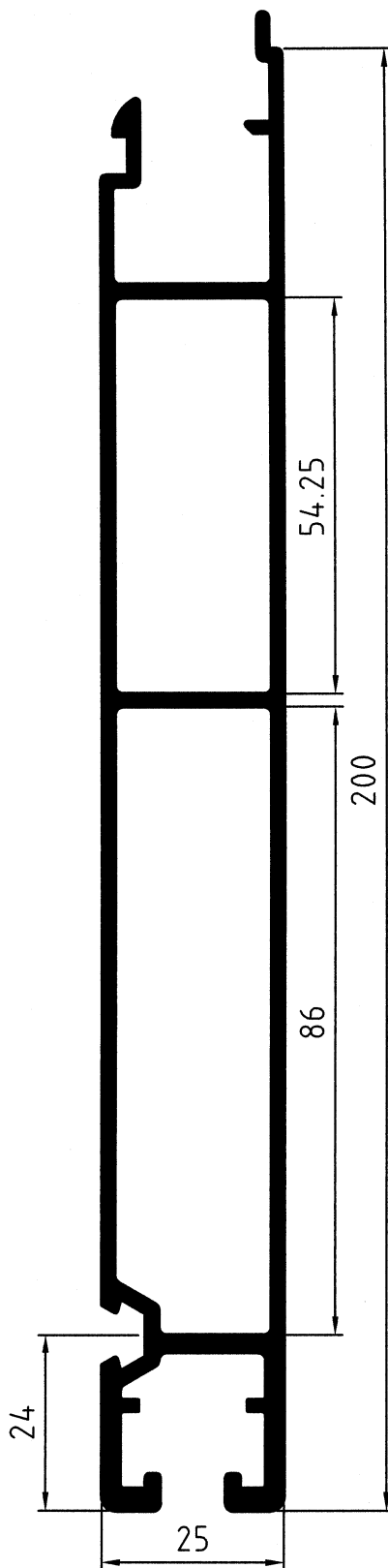

FT 61796
2,49 kg/m
code
321718 7,60 m Anod.
521718 7,60 m

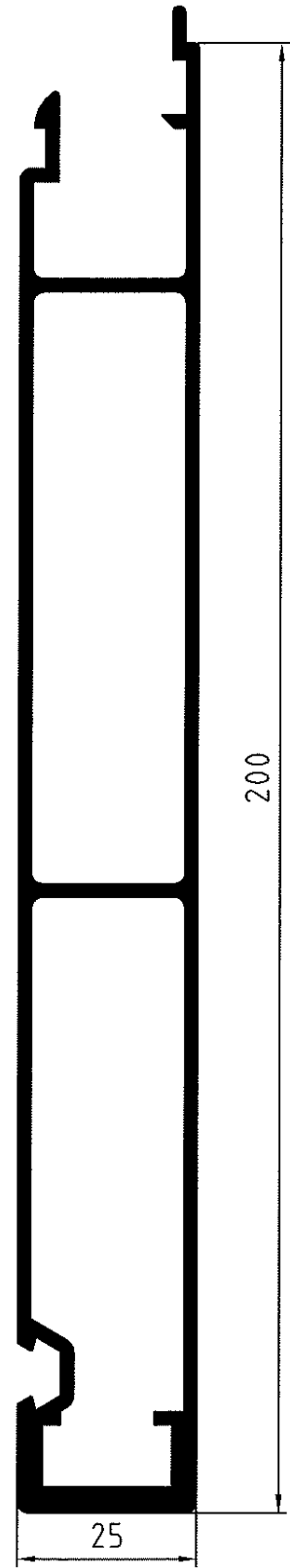

DC 07554
2,59 kg/m
Code
903522 6,65 m Anod.
525214 6,65 m
903523 7,60 m Anod.
1100442 7,60 m

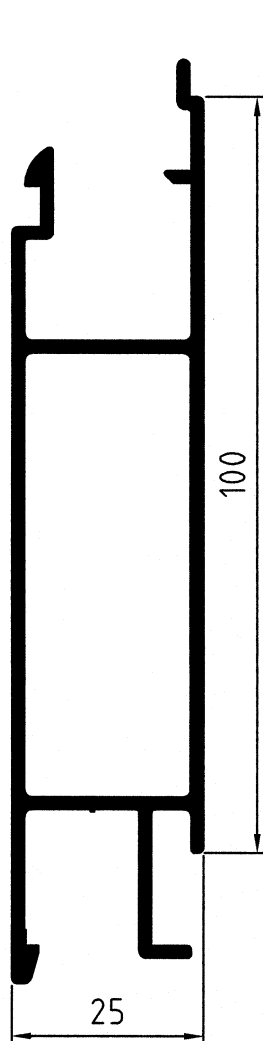

FT 60359

1,32 kg/m

code

321014 6,65 m Anod.

321018 7,60 m Anod.

521014 6,65 m

521018 7,60 m

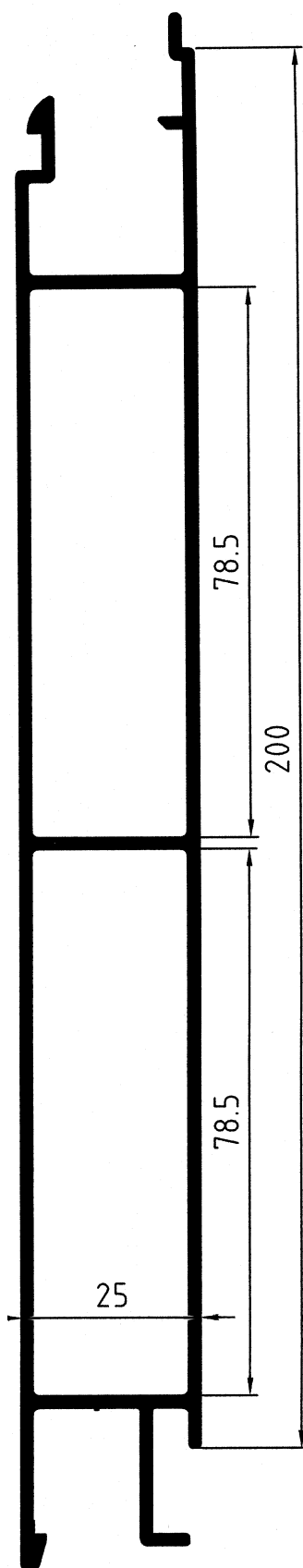

FT 60357

2,32 kg/m

code

320414 6,65 m Anod.

320418 7,60 m Anod.

520414 6,65 m

520418 7,60 m

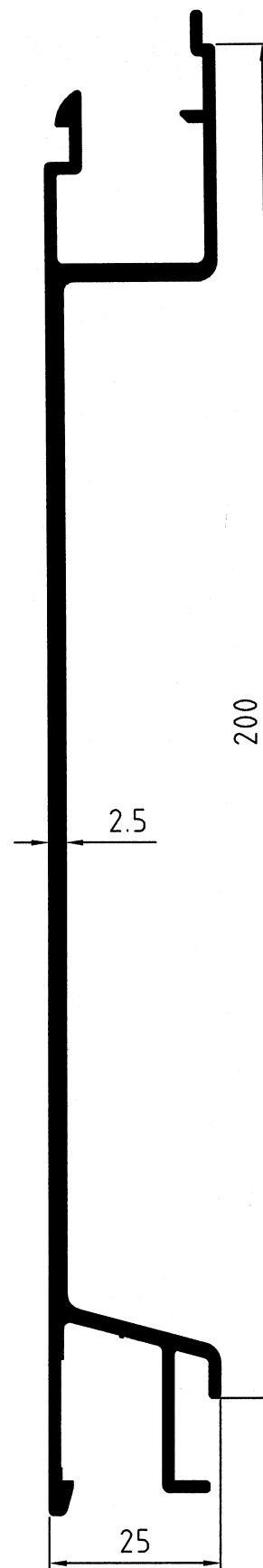

FP 60358

1,94 kg/m

code

320518 7,60 m Anod.

520518 7,60 m

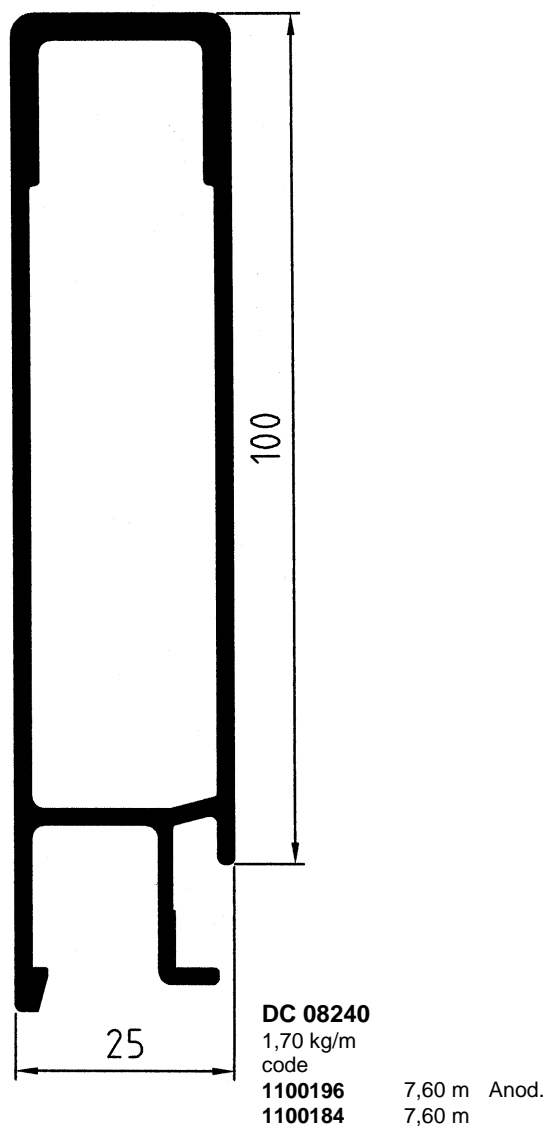
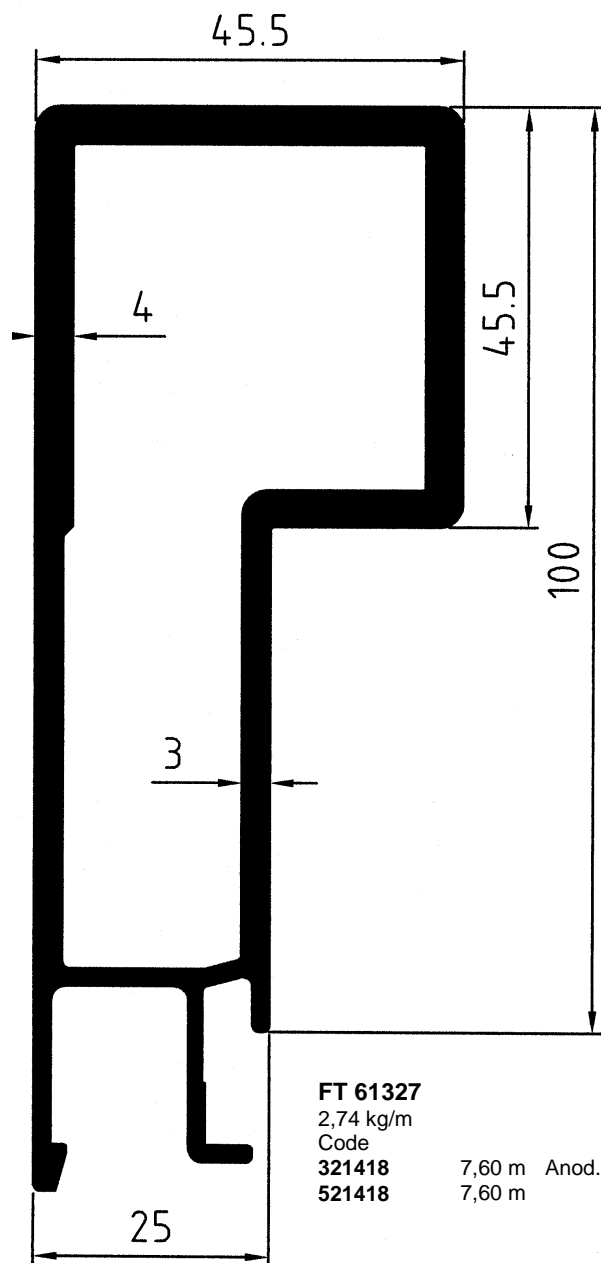

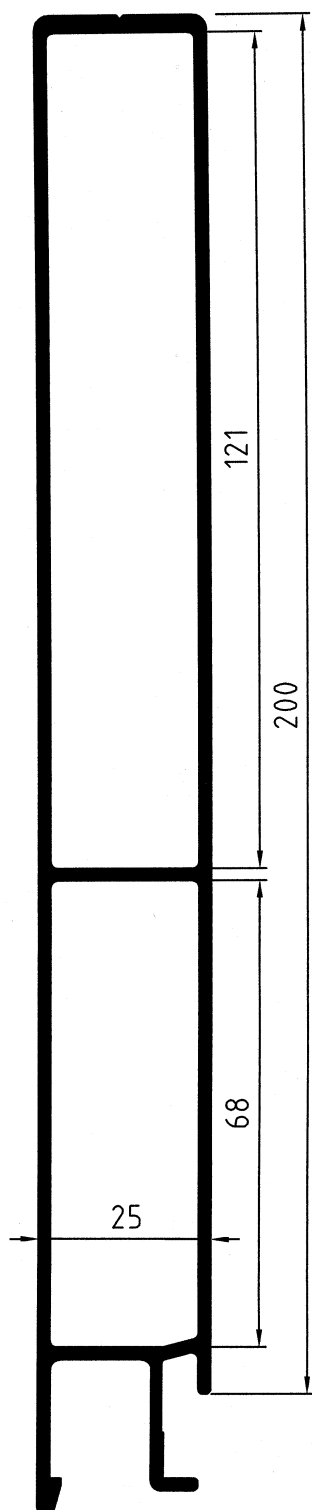

FT 61329

2,45 kg/m
code

320614	6,65 m	Anod.
320618	7,60 m	Anod.
520614	6,65 m	
520618	7,60 m	

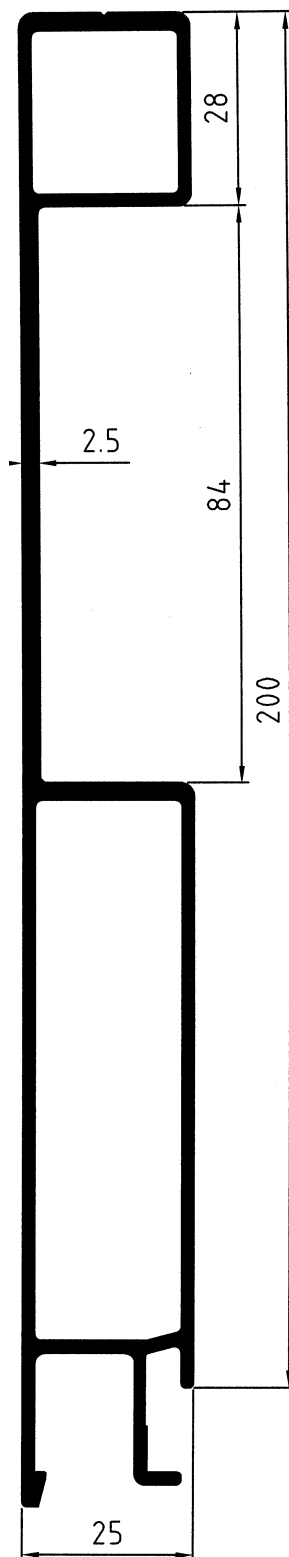

FT 61328

2,39 kg/m
code

325618	7,60 m	Anod.
525618	7,60 m	

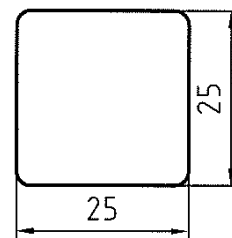
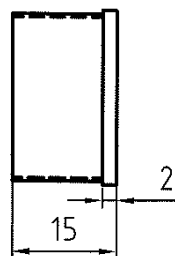







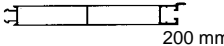
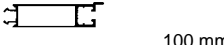

AN 677
0,01 kg/st-p
code
643104

Leverbaar op aanvraag.

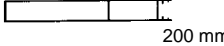
Disponible au demandé.

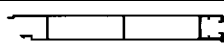
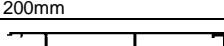
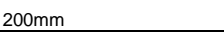

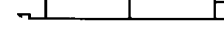
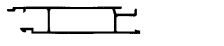



Lieferbar auf Anfrage.

Profiel nr. Nr. de profil Profil Nr.	Gewicht Poids Gewicht	Symbol Symbole Symbol	Beschrijving Description Bezeichnung
FL 22732	2,66 kg/m	 200 mm	Onderrandprofiel Profilé inférieur Unteres Randprofil
FL 22733	1,66 kg/m	 100 mm	
FL 22730	2,38 kg/m	 200 mm	Tussenprofiel Profilé intermédiaire Zwischenprofil
FL 22729	1,33 kg/m	 100 mm	
FL 23166	0,86 kg/m	 50 mm	
FL 22727	2,29 kg/m	 200 mm	Bovenrandprofiel Profilé supérieur Oberes Randprofil
FL 22728	1,24 kg/m	 100 mm	
DC 07783	2,68 kg/m	 200mm	Onderrandprofiel Profilé inférieur Unteres Randprofil
DC 10513	2,55 kg/m	 200mm	
DC 07045	2,05 kg/m	 200mm	Tussenprofiel Profilé intermédiaire Zwischenprofil
DC 07046	2,54 kg/m	 200mm	
DC 07785	1,45 kg/m	 100mm	
DC 11284	2,10 kg/m	 100mm	

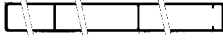

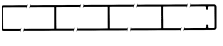

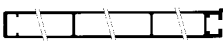
**Zijbord
Ridelle
Bordwand**

ET 25 mm

A-3-1

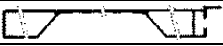
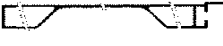
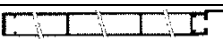
Blz. Page Seite	Profiel nr. Nr. de profil Profil Nr.	Gewicht Poids Gewicht	Symbool Symbole Symbol	Beschrijving Description Bezeichnung	Lengte Longueur Länge
A-3-2	FL 28942	3,30 kg/m		Zijbordprofiel 300 mm	7,50 m
	AL 57297	3,57 kg/m		Profilé ridelle 300 mm	7,50 m
	AL 42894	4,30 kg/m		Bordwandprofiel 400 mm	*
A-3-3	AL 57188	4,28 kg/m		Zijbordprofiel 400 mm Profilé ridelle 400 mm	7,20 m
	AL 56501	5,36 kg/m		Bordwandprofiel 400 mm	7,50 m
	AL 30943	3,94 kg/m			7,50 m

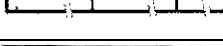
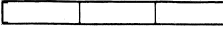
Op aanvraag af fabriek / Départ usine sur demande / Auf Anfrage ab Werk

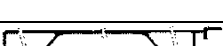
AL 28287	3,40 kg/m		Zijbordprofiel 300 mm	*
AL 25469	3,38 kg/m		Zijbordprofiel 350 mm	*
AL 29333	3,70 kg/m		Profilé ridelle 350 mm	*
AL 27775	3,30 kg/m			*
AL 26107	3,70 kg/m		Bordwandprofiel 350 mm	*
AL 41507	4,70 kg/m		Zijbordprofiel 400 mm	*
AL 41401	4,15 kg/m		Profilé ridelle 400 mm	*
AL 41402	4,25 kg/m		Bordwandprofiel 400 mm	*
AL 37184	4,70 kg/m		Bordwandprofiel 422 mm Zijbordprofiel 422 mm Profilé ridelle 4220 mm	*

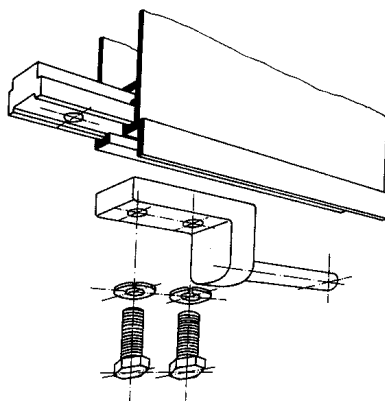

Zie / voir / Siehe
blz./ page / Seite
T

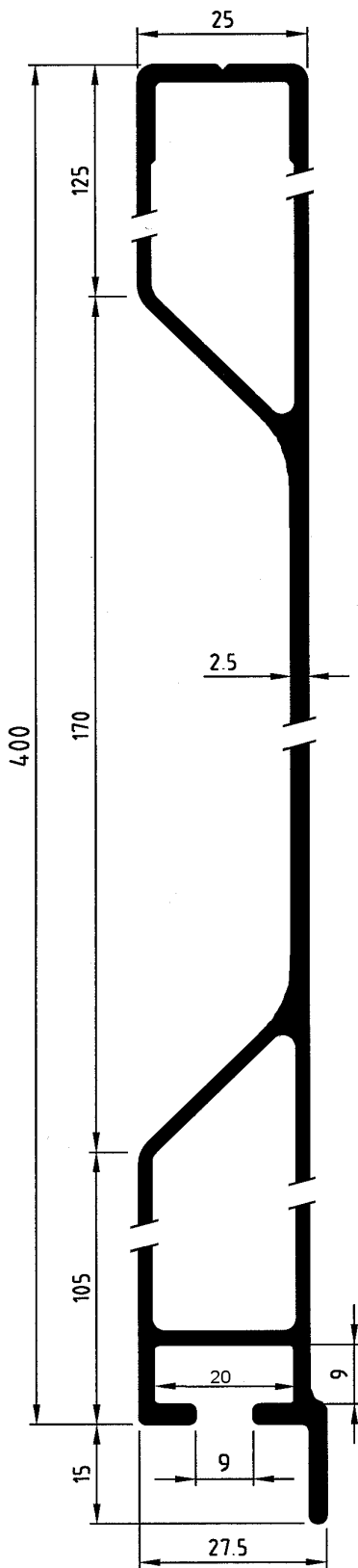

AL 57188

4,28 kg/m

code

1100423 7,50 m Anod.

1100422 7,50 m

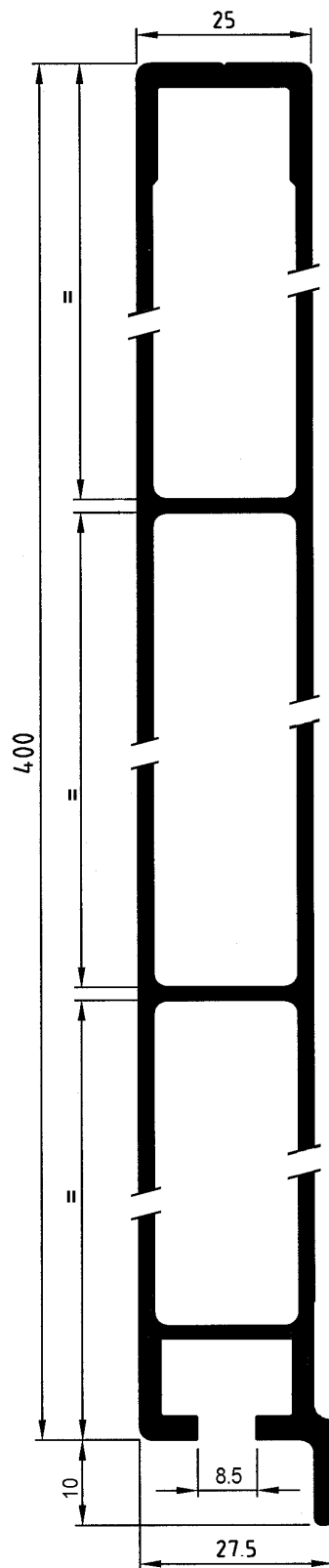

AL 56501

5,10 kg/m

code

353117 7,50 m Anod.

363117 7,50 m

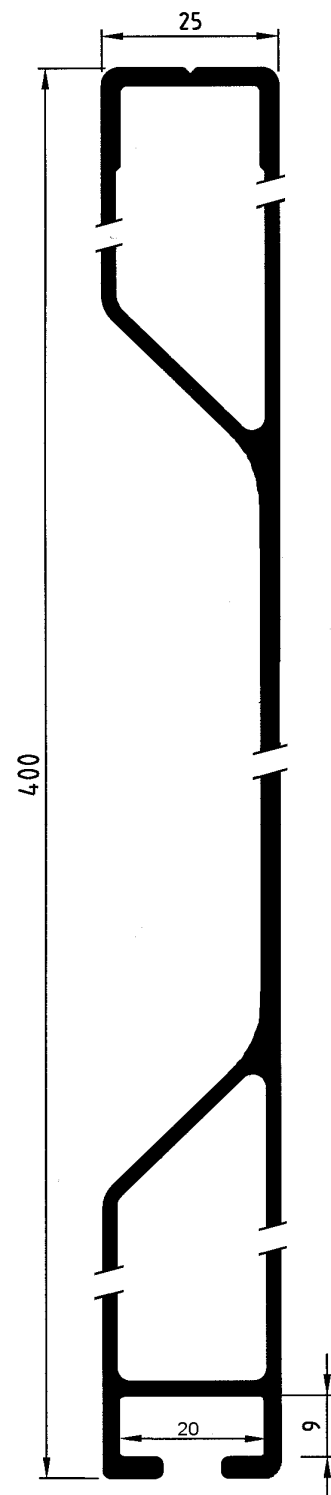

AL 30943

4,65 kg/m

code

355117 7,50 m Anod.

Zijrandprofiel zijborden
 Embout de ridelle
 Einfaßprofile Bordwände

30 mm

A-4-1

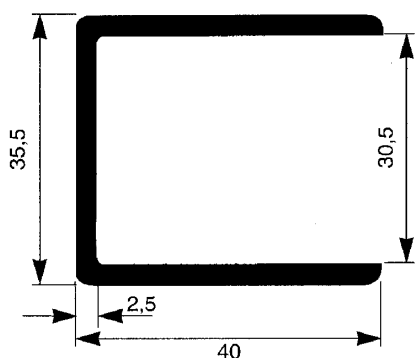

FL 00154
 0,76 kg/m
 code
450609 6,00 m Anod.
370609 6,00 m

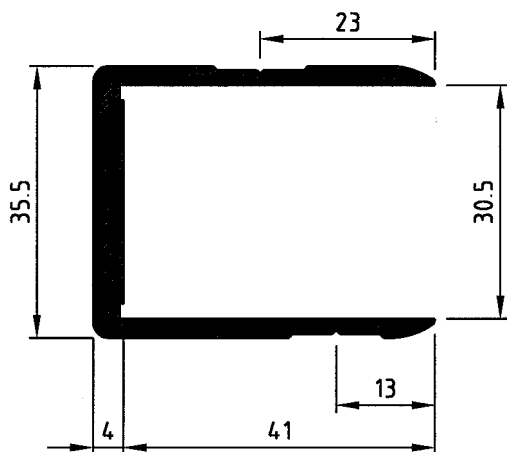

FL 00603
 0,90 kg/m
 code
371409 6,00 m

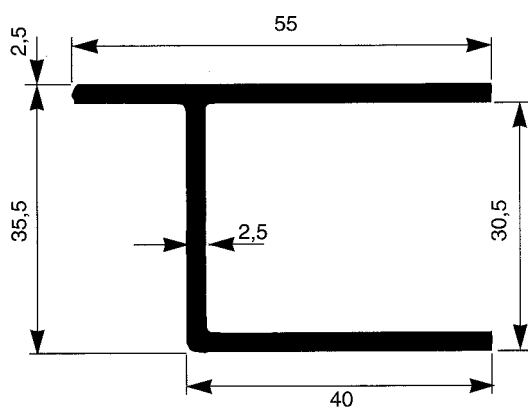

FL 00156
 0,85 kg/m
 code
450509 6,00 m Anod.
370509 6,00 m

KINNEGRIP K IV

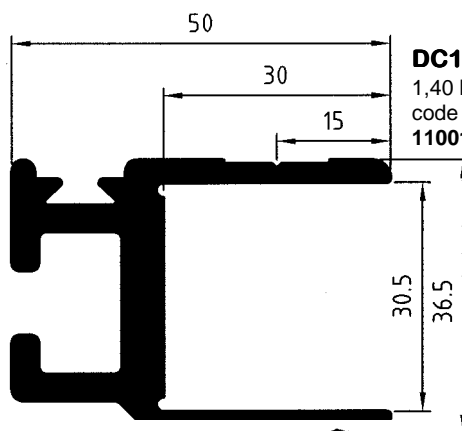

DC10507
 1,40 kg/m
 code
1100162 7,20 m

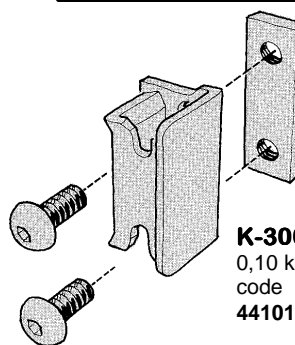

K-30023
 0,10 kg/st-p
 code
441013

KINNEGRIP K20

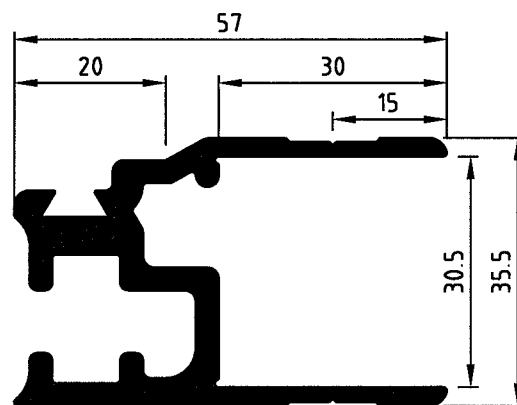

DC 07518
 1,33 kg/m
 code
903007 6,00 m

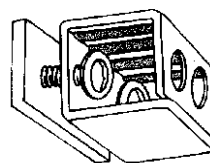

K-12161
 0,10 kg/st-p
 code
952004

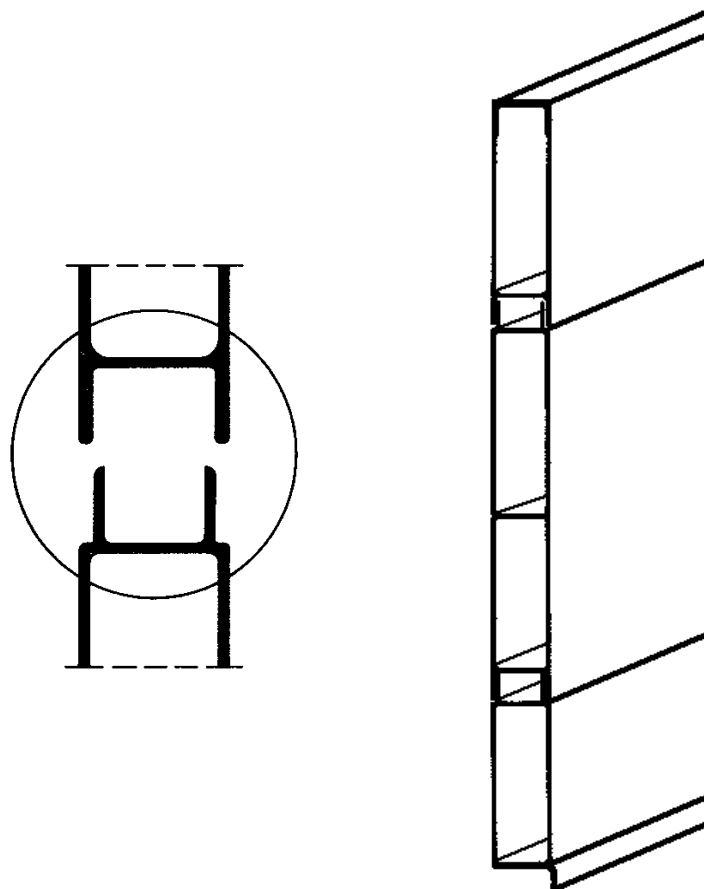

Blz. Page Seite	Profiel nr. Nr. de profil Profil Nr.	Gewicht Poids Gewicht	Symbol Symbole Symbol	Beschrijving Description Bezeichnung	Lengte Longueur Länge
A-4-3	FL 20013 *	1,91 kg/m	 120 mm	Bovenrandprofiel Profilé supérieur	*
	DC 08266	2,90 kg/m	 200 mm	Oberes Randprofil	7,35 m
	FL 20016 *	1,58 kg/m	 88 mm	Onderrandprofiel Profilé inférieur	*
	FL 20015 *	1,49 kg/m	 88 mm	Unteres Randprofil	*
A-4-4	FL 20064	2,94 kg/m	 200 mm	Tussenprofiel	7,35 m
	AL 43636	3,91 kg/m	 300mm	Profilé intermédiaire	6,2 m 7 m
	AL 03349	2,79 kg/m	 200mm	Zwischenprofil	6,2 m 7 m

* op aanvraag / sur demande / Auf Anfrage

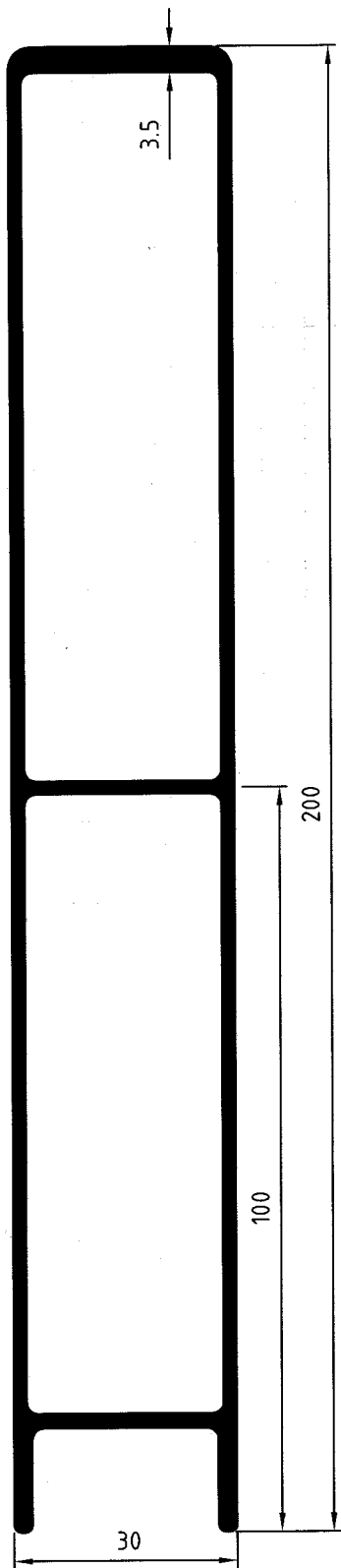

DC 08266
2,90 kg/m
Code
1100163 7,35 m

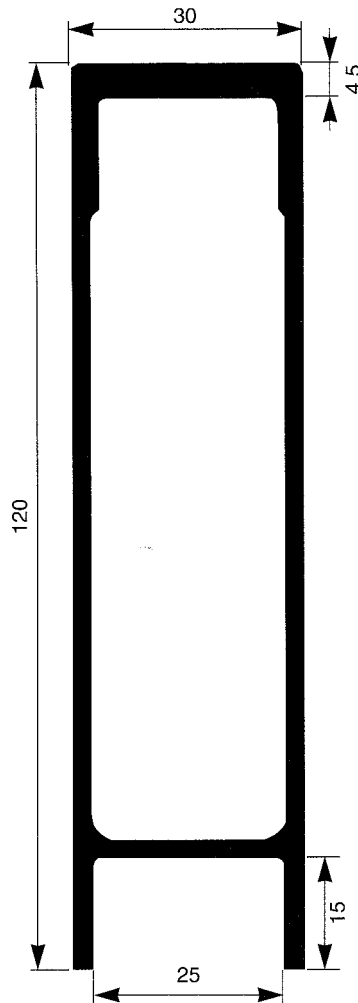

FL 20013
1,91 kg/m

*

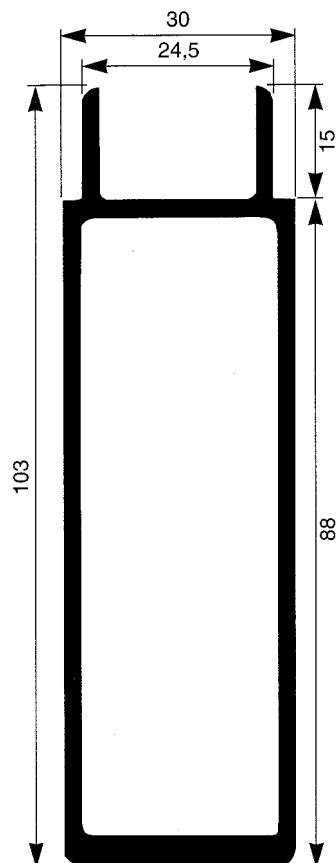

FL 20015
1,49 kg/m

*

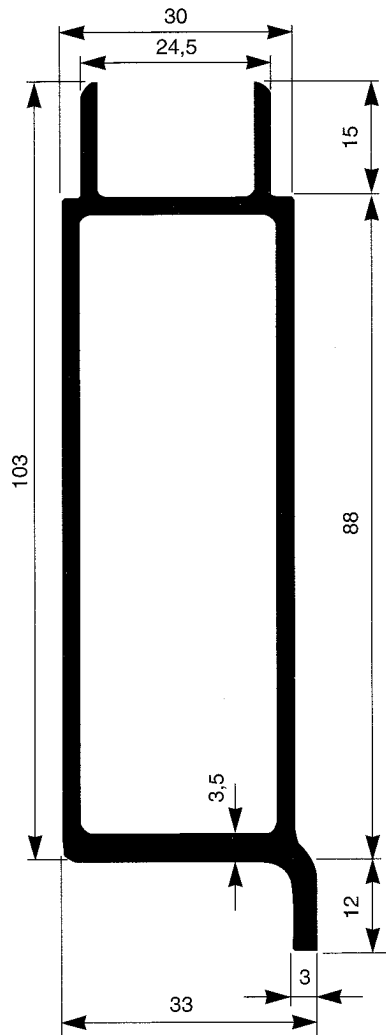

FL 20016
1,58 kg/m

*

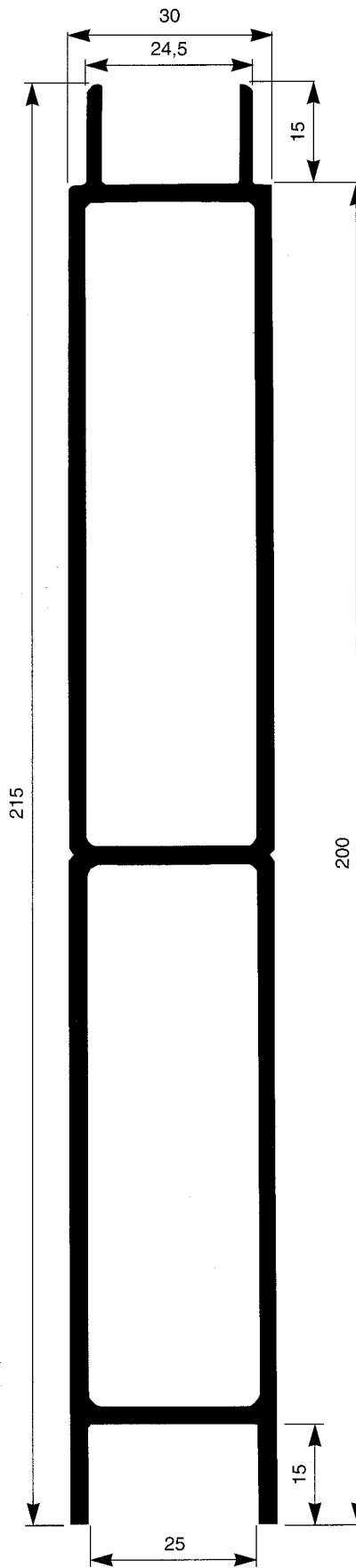

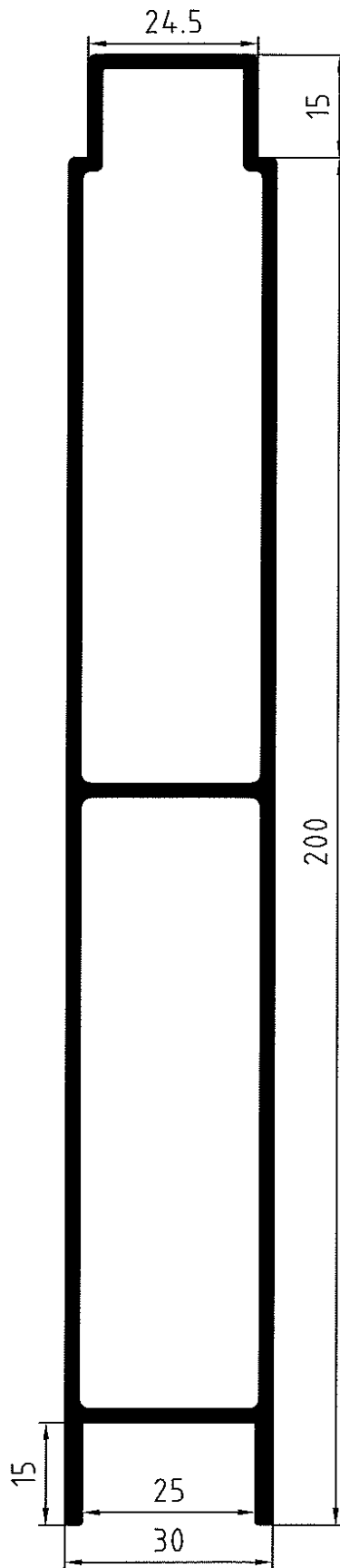

FL 20064
2,94 kg/m
code
371016 7,35 m

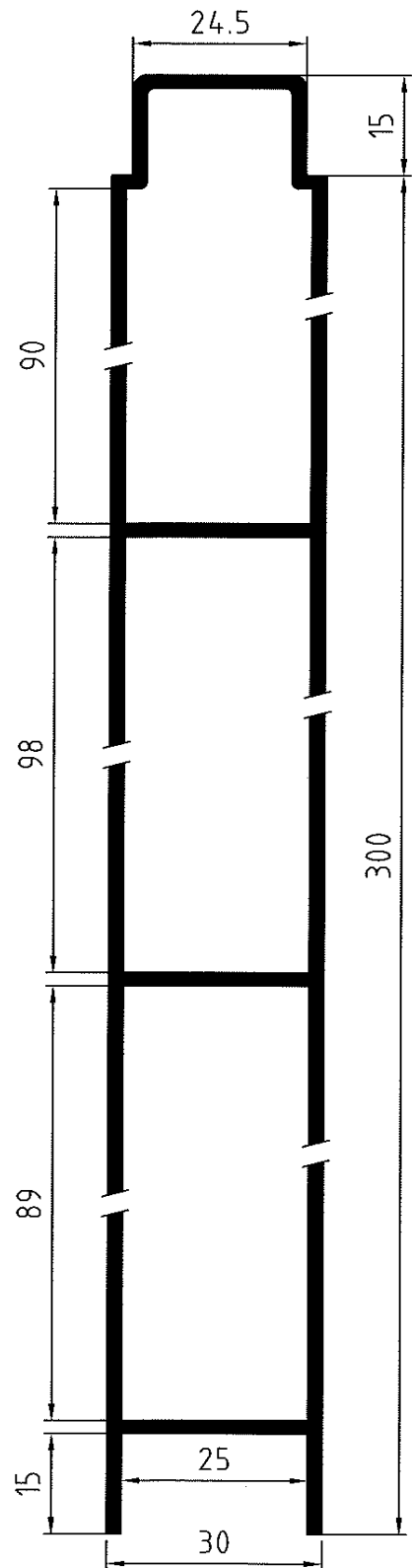

AL 03349
2,79 kg/m
code
1104726 6,20 m
1104725 7,00 m

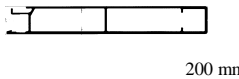

AL 43636
3,91 kg/m
Code
1104590 6,20 m
1104589 7 m

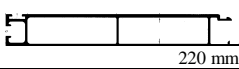
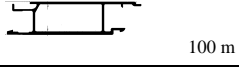
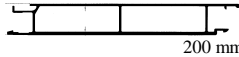
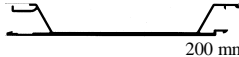
Blz. Page Seite	Profiel nr. Nr. de profil Profil Nr.	Gewicht Poids Gewicht	Symbol Symbole Symbol	Beschrijving Description Bezeichnung	Lengte Longueur Länge
A-5-2	DC 11924	3,49 kg/m		Bovenrandprofiel Profilé supérieur Oberes Randprofil	7,50 m
	AN 8 AS	0,10 kg/m		Kunststofprofiel Joint Dichtgummi	
	DC 11925	3,57 kg/m		Onderrandprofiel Profilé inférieur Unteres Randprofil	7,50 m
A-5-3	DC 12008	1,90 kg/m		Tussenprofiel Profilé intermédiaire Zwischenprofil	7,50 m
	DC 11448	3,40 kg/m			7,50 m
	DC 11923	2,60 kg/m		Tir-profiel Profilé TIR Planösenprofil	7,50 m



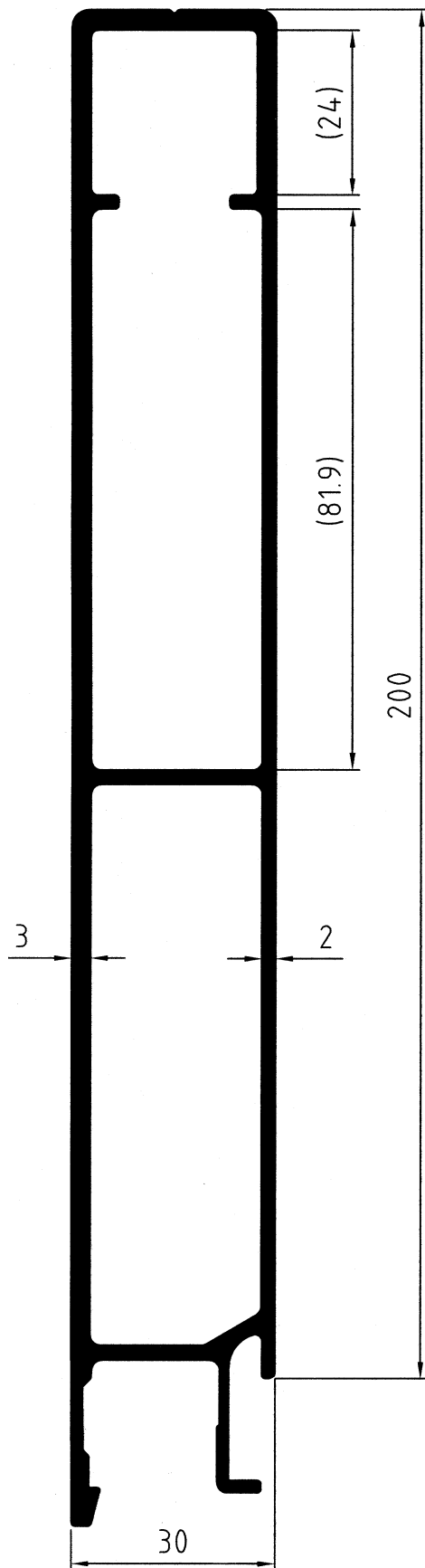

DC 11924
3,49 kg/m
code
1102271 7,50 m

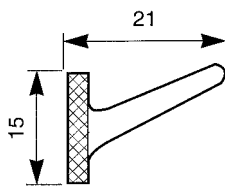

AN 8 AS
0,1 kg/m
code
444020 100 m

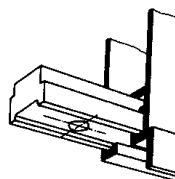

AB 6932
0,09 kg/st-p
code
1103017

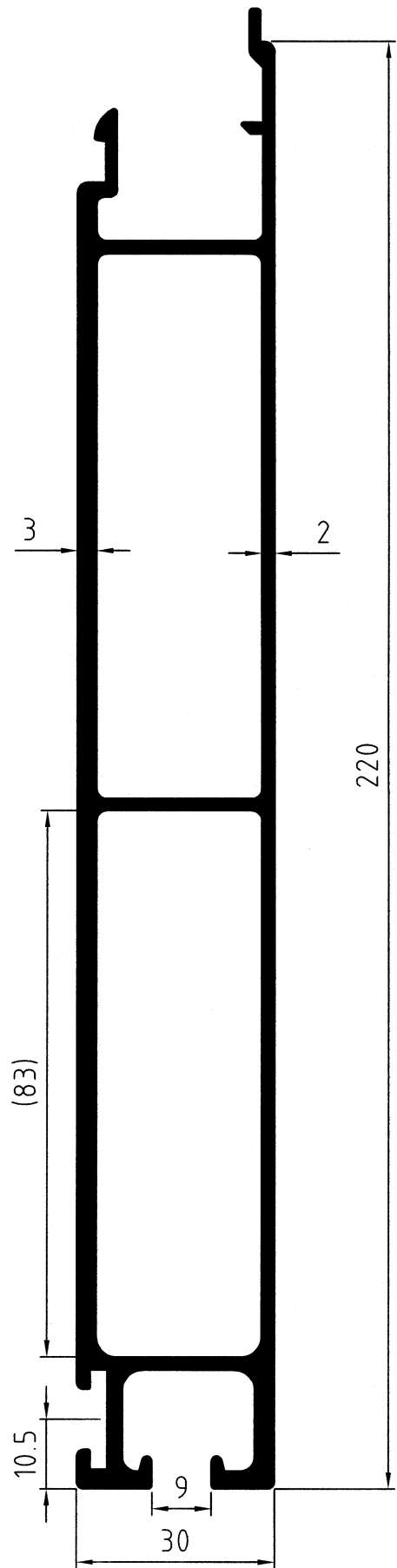

DC 11925
3,57 kg/m
code
1102270 7,50 m

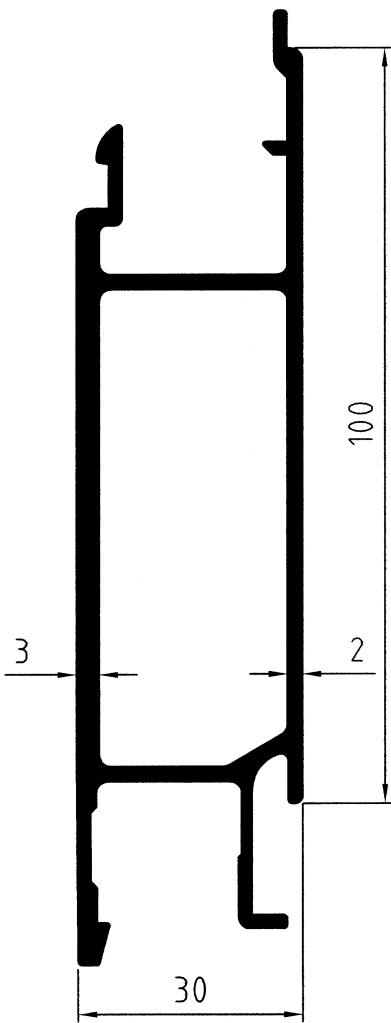

DC 12008
1,90 kg/m
code
1102397 7,50 m

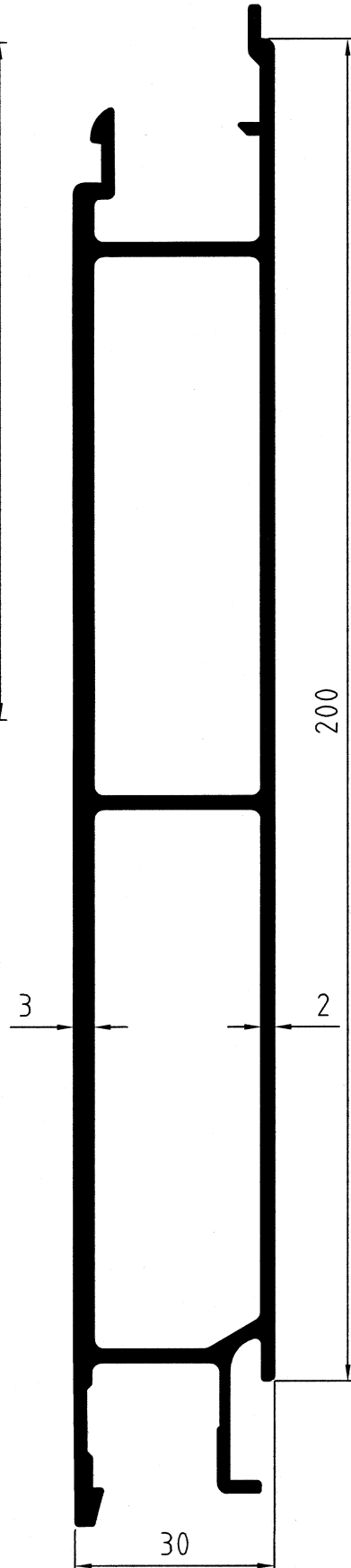

DC 11448
3,40 kg/m
code
1101127 7,50 m

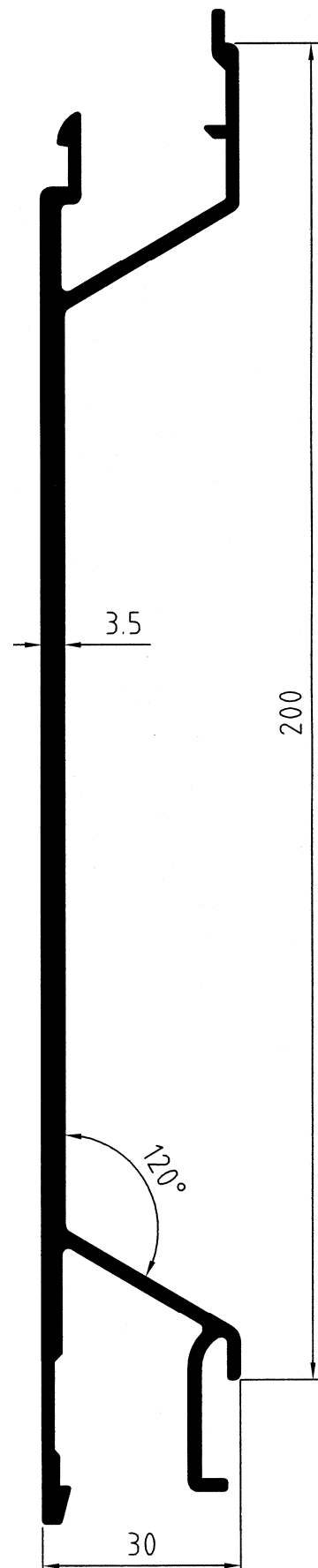

DC 11923
2,60 kg/m
code
1102268 7,50 m

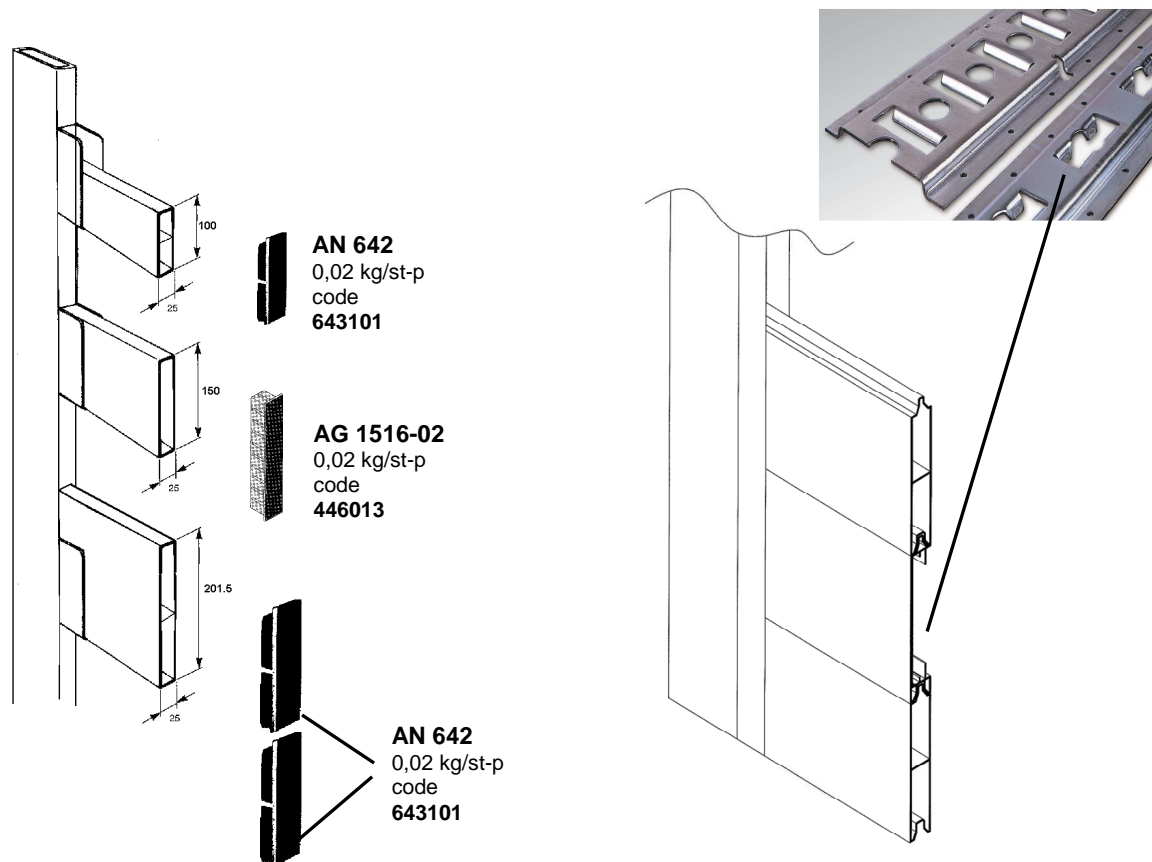

Blz. Page Seite	Profiel nr. Nr. de profil Profil Nr.	Gewicht Poids Gewicht	Symbol Symbole Symbol	Beschrijving Description Bezeichnung	Lengte Longueur Länge
A-6-2	FL 20131	1,46 kg/m	 100 mm	Ladinglat	6,65 m 7,50 m
	FL 20298	2,34 kg/m	 150 mm	Rehausse	5,30 m 6,65 m 7,50 m
	DC 08231	2,31 kg/m	 201.5 mm		7,50 m
	FL 28942	3,30 kg/m	 300 mm	Spiegelprofil	
A-6-3	DC 07970	2,00 kg/m	 150 mm	Ladinglat Rehausse	3,24 m 6,65 m 7,50 m
	AL 27796	1,90 kg/m	 155 mm	Spiegelprofil	7,50 m
	AL 28014	1,10 kg/m	 100 mm		
A-6-4	FL 22990	3,63 kg/m	 89.3 x 24.4 mm	Rongprofielen Profils de rancher	6,00 m
	FL 22989	3,85 kg/m	 160 x 35 mm	Rungenprofile	6,00 m
	DC 07335	1,98 kg/m	 150 mm	Ladinglat Rehausse Spiegelprofil	*

Ladinglat

Profils de bache latérale

Spiegelprofile

A-6-2

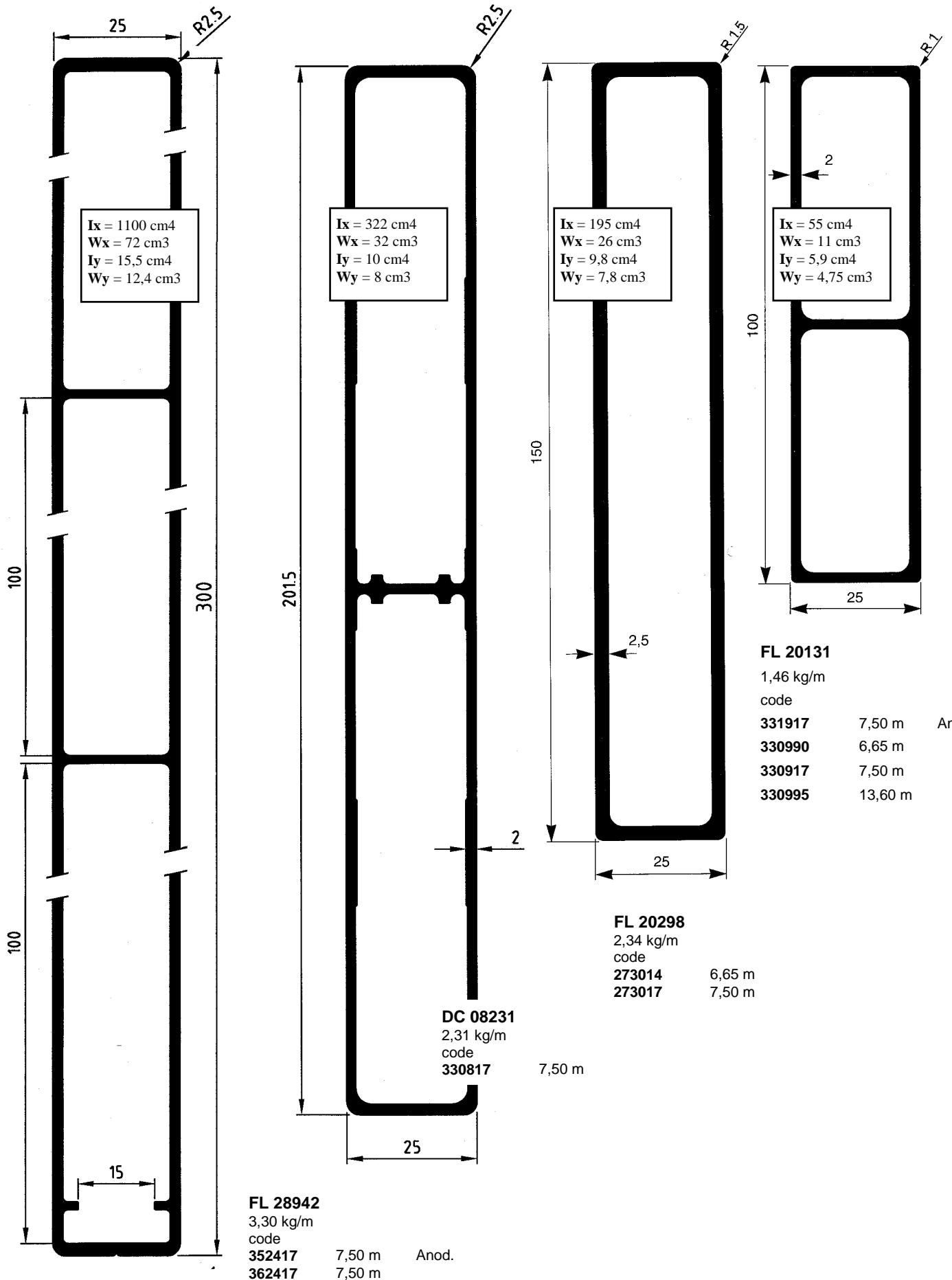

Ladinglat
 Profilés de bâche latérale
 Spriegelprofile

A-6-3

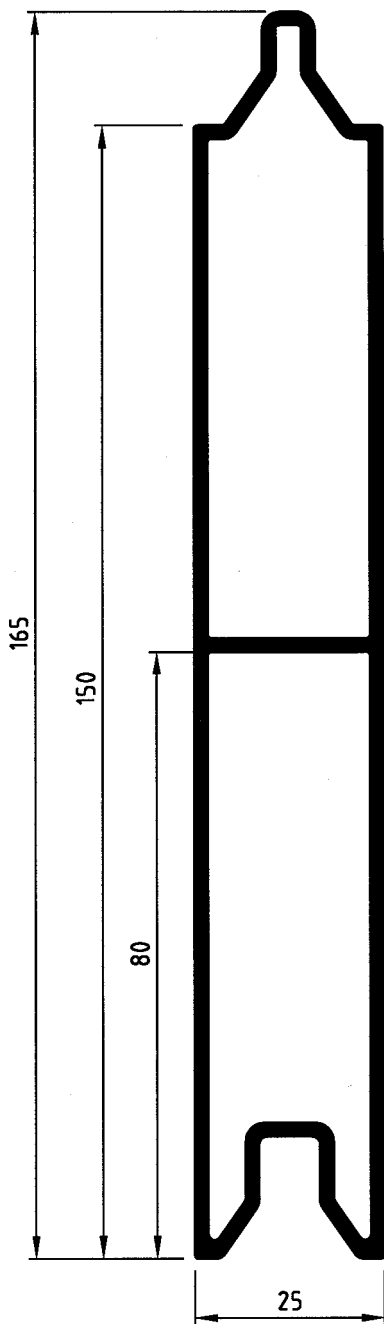

DC 07970
 2,00 kg/m
 code
1100232 3,24 m
403514 6,65 m
903055 7,50 m

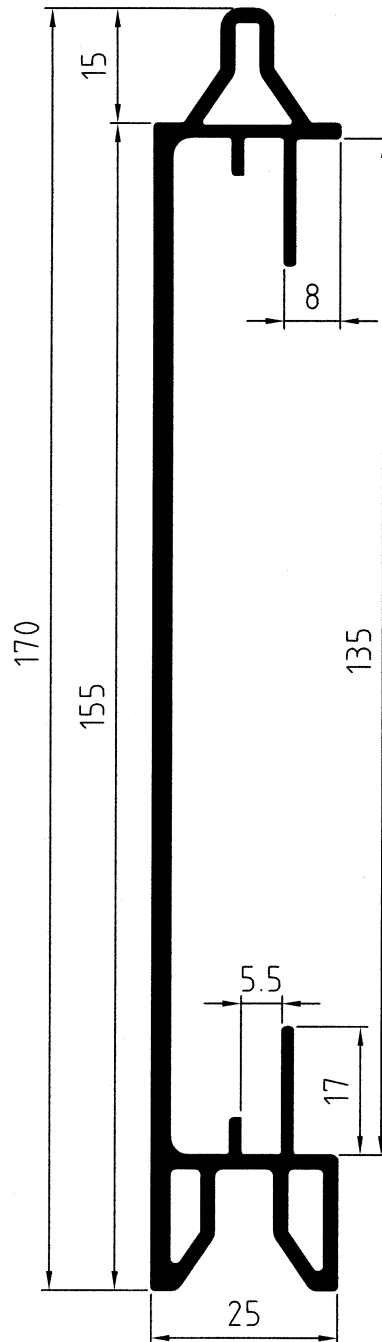

AL 27796
 1,90 kg/m
 code
1102399 7,50 m

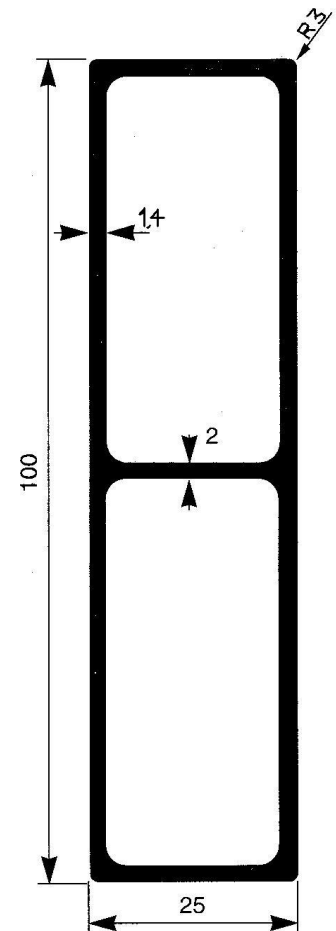

AL 28014
 1,1 kg/m
 code
 *

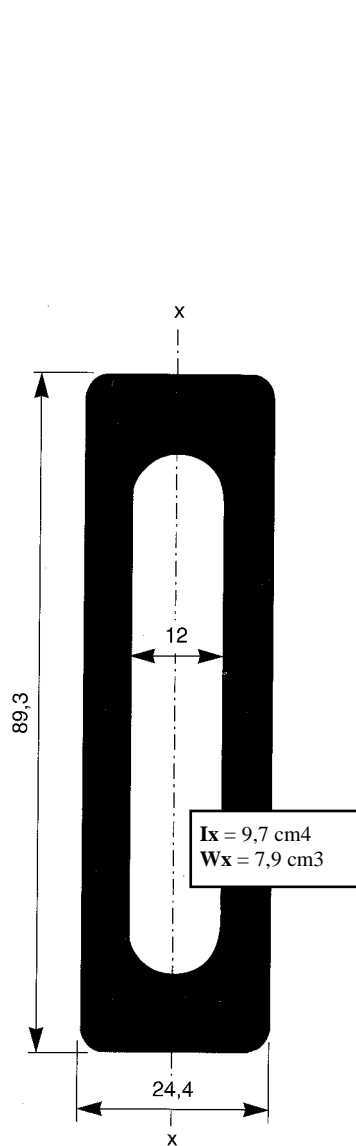
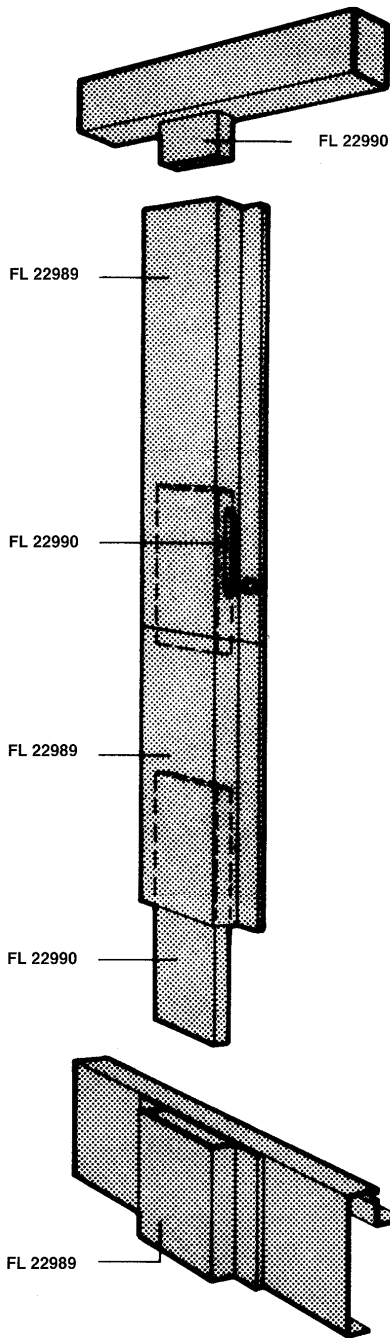

FL 22990
 3,63 kg/m
 code
403109 6,00 m

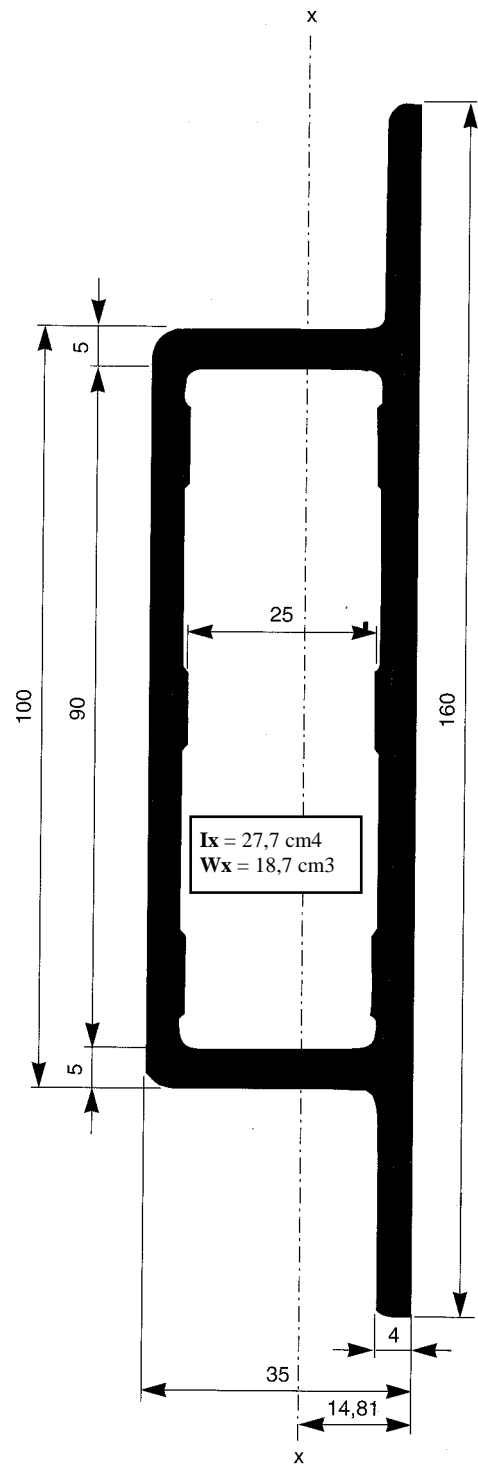

FL 22989
 3,85 kg/m
 code
403009 6,00 m

**Buisprofilen met radius.
Tubes aux coins arrondis
Rohrprofilen mit Radius**

A-7-1

Blz. Page Seite	Profiel nr. Nr. de profil Profil Nr.	Gewicht Poids Gewicht	Afmetingen Dimension Abmessungen	Legering Alliage Legierung	Lengte Longueur Länge
A-7-2	FL 21441	2,14 kg/m	60 * 30 * 5 mm.	6005A	6,00 m
	FL 21443	3,93 kg/m	82 * 52 * 5.7 mm.	6005A	6,00 m
	FL 21439	2,68 kg/m	70 * 40 * 4.7 mm.	6005A	6,00 m
	CH 41907	10,70 kg/m	120 * 120 * 9 mm.	6082	5,00 m 6,60 m
A-7-3	DC 07829	0,60 kg/m	25 * 25 * 2.5 mm.	6005A	6,00 m
	AL 12042	1,00 kg/m	40 * 40 * 2.5 mm.	6005A	6,00 m
	DC 07958	1,60 kg/m	40 * 40 * 4 mm.	6005A	6,00 m 7,50 m
	DC10030	1,30 kg/m	60 * 40 * 2.5 mm.	6005A	6,00 m
	DC 07959	2,04 kg/m	60 * 40 * 4 mm.	6005A	6,00 m 7,50 m
	DC 08218	2,48 kg/m	80 * 40 * 4 mm.	6005A	6,00 m 7,50 m
	DC 08219	2,93 kg/m	100 * 40 * 4 mm.	6005A	6,00 m 7,50 m
	DC 10148	5,80 kg/m	100 * 50 * 8 mm.	6005A	6,00 m
A-7-4	AL 12109	4,45 kg/m	100 * 100 * 4 mm.	6060	6,00 m
	AL 12106	5,13 kg/m	100 * 100 * 5 mm.	6060	6,00 m

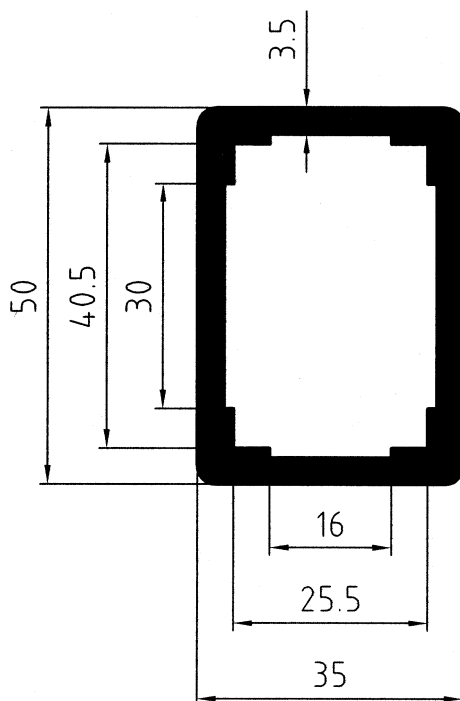

DC 07686
1,61 kg/m
code
1100095 7,60 m

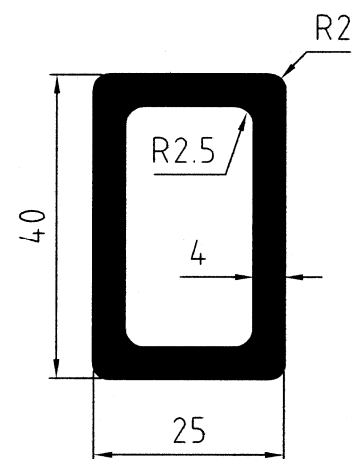

AL 10832
1,27 kg/m
code
1100495 7,60 m

Rongprofielen Profilés de rancher Rungenprofile

A-7-2

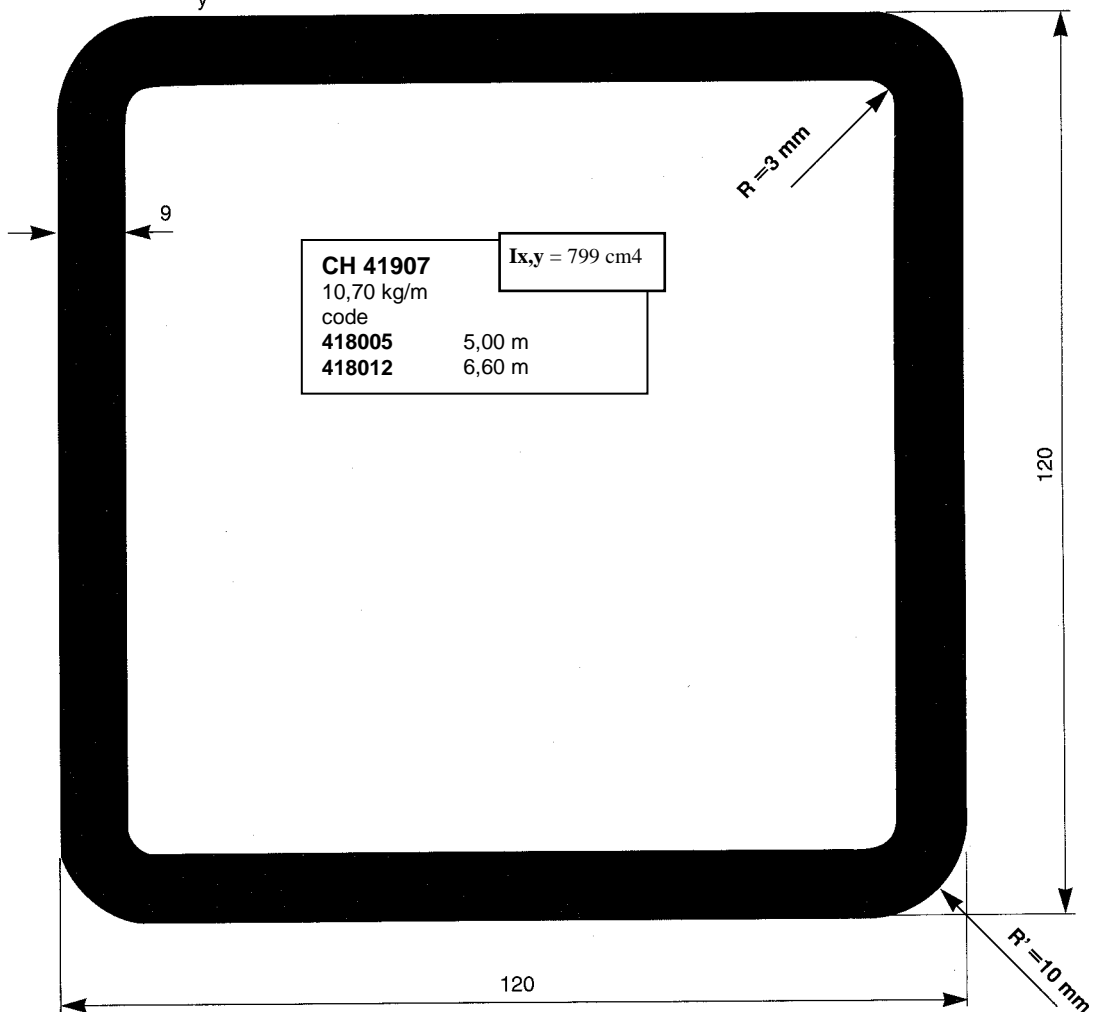
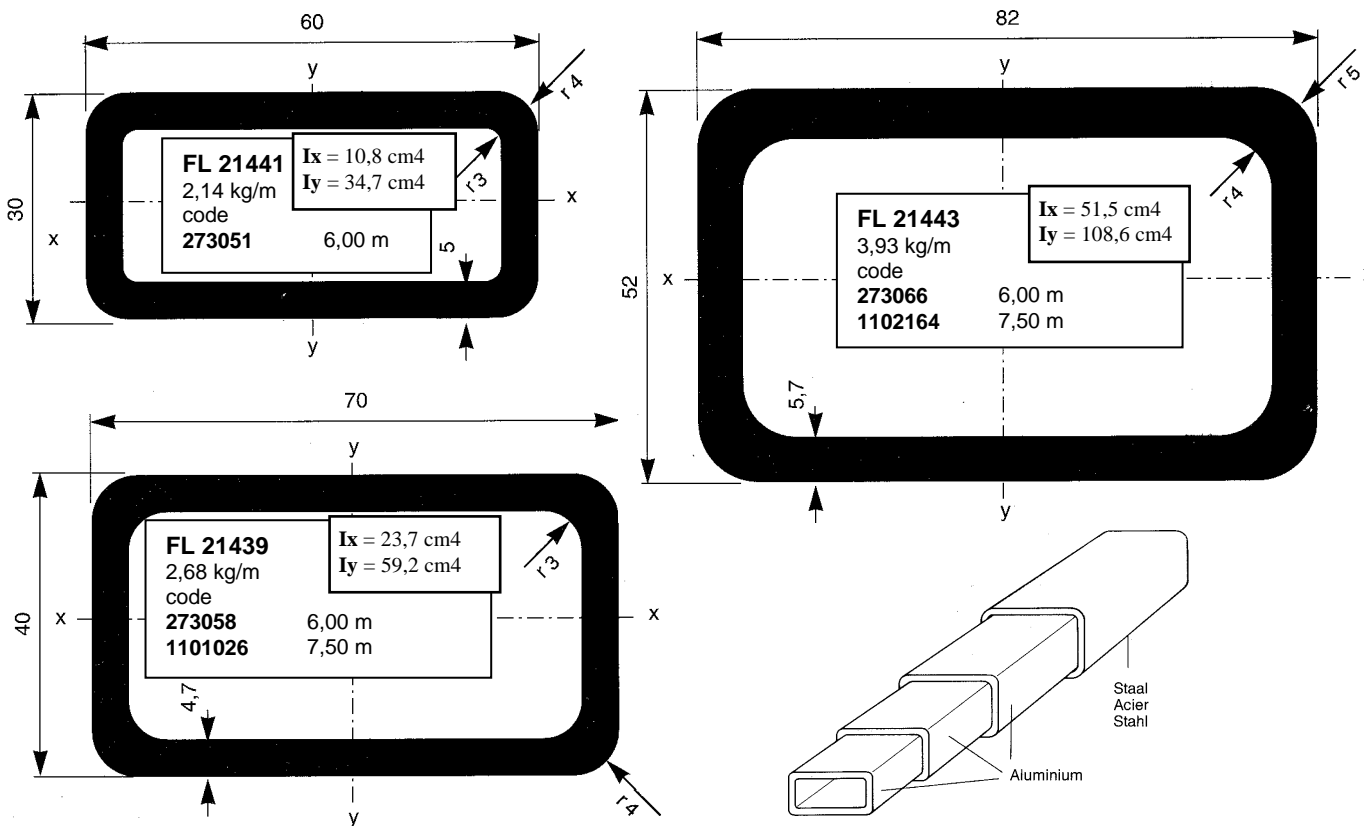

Buisprofilen met radius.
 Tubes aux coins arrondis
 Rohrprofilen mit Radius

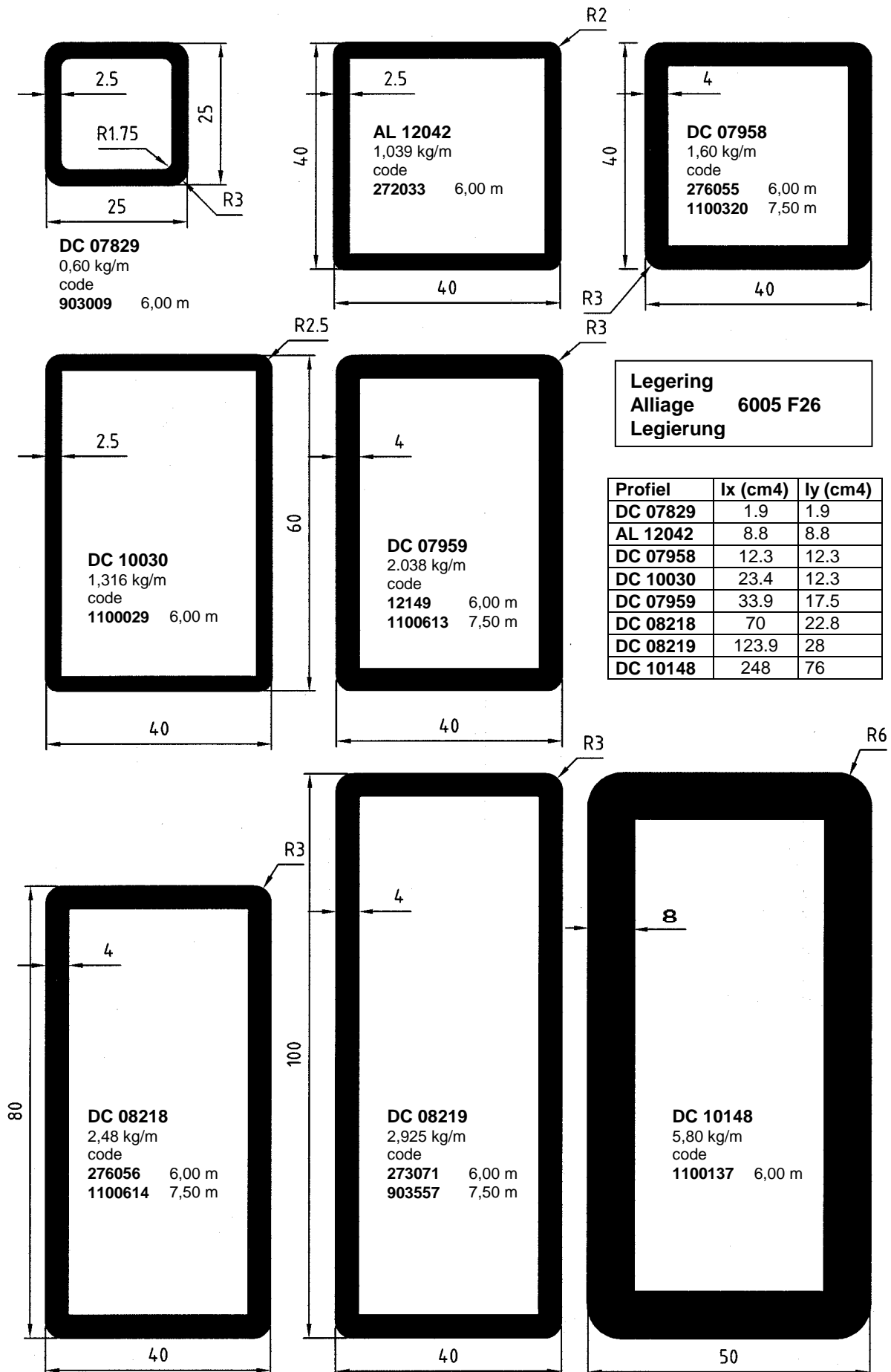

Buis profielen met radius.
Tubes aux coins arrondis
Rohrprofilen mit Radius

