

Gesloten opbouw Fourgon Kastenwagen

D-1-1

Paneeldikten Épaisseur des panneaux Paneldicken								Blz. / Page / Seite		
Panelen Panneaux Platten	CORAPAN - ALU						20	25	D-1-2 D-1-2 / D-1-3	
	CORAPAN - GFK						20	25		
	ALUCORE				6	10	15	20	25	D-1-3 / D-1-4 D-1-5 D-1-6
	ALUCOBOND		3	4	6					
	DIBOND	2	3	4	6					
	Hulprofielen - Profils d'assemblage - Montageprofilen 3 – 4 mm.								D-1-7	
	Klemstijl met toebehoren		Profile de clamage avec accessoires			Klemmprofil mit Zubehör			D-1-8	
	Alu klepscharnier		Charnières-alu de porte			Alu-Scharnieren			D-1-9	
C3000	15 – 20 – 25 – 30 mm							D-1-10		
	20 mm							D-2		
	25 mm							D-3		
	30 mm							D-4		
	Koelwagen paneelconstructie	Fourgon frigorifique construction panneaux			Kühlwagen Panel-Aufbau			D-5		
	Zeildoekwagen	Rideau coulissant			Seiltuchwagen			E-1-1		



Panelconstructie Construction Panneaux Panel-Aufbau

D-1-2

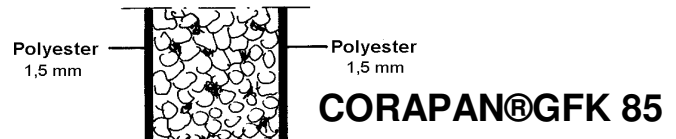
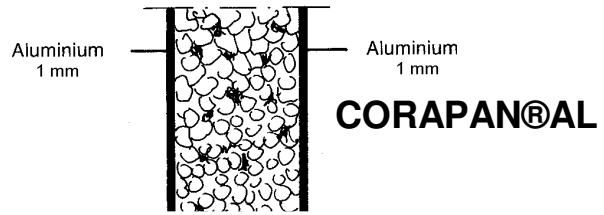
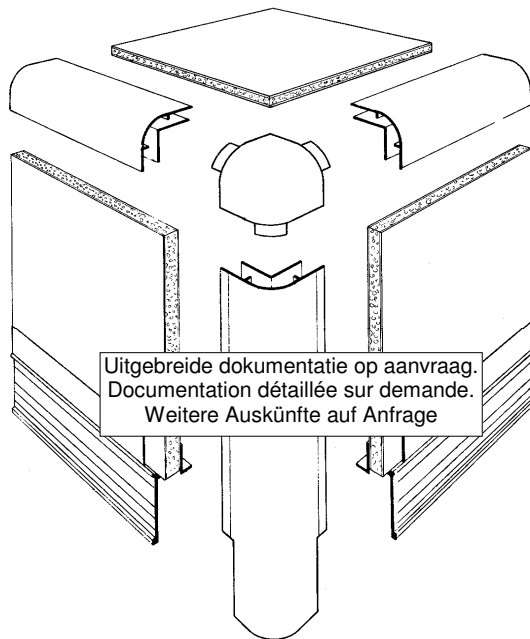

Type	Afmetingen Dimensions Abmessungen d x b x l (mm)	Gewicht Poids Gewicht ± 3%	K-waarde Valeur-K K - Wert (W/m ² .K)	Oppervlakte-uitvoering État de surface Oberfläche Ausführung	code
Corapan AL 85	20 x 2180 x 5980	7,0 kg/m ²	1,36	RAL 9010 / RAL 9010	*481250
Corapan AL 85	25 x 2180 x 5980	7,5 kg/m ²	1,14	RAL 9010 / RAL 9010	*481550
Corapan GFK 85	20 x 2180 x 5980	5,1 kg/m ²	-	Polyester / polyester	*482250
Corapan GFK 85	25 x 2180 x 5980	5,6 kg/m ²	-	Polyester / polyester	*482550

* op aanvraag / Sur demande / Auf Anfrage

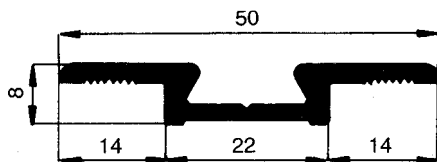

FL 06823
0,44 kg/m
code
430809

6,00 m

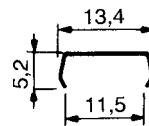

M 18908
0,035 kg/m
code
430304

6,00 m

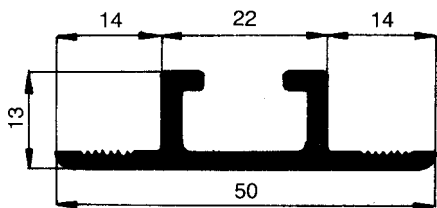

FL 06824
0,51 kg/m
code
430909

6,00 m

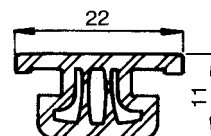

AN 585
PVC
code
446058

6,00 m

ALUCORE®

Honingraatpanelen	Panneaux en nid d'abeille	Wabenkern-Verbundplatten
Voor extreem lichte aluminium constructies en hoge belastingen.	Pour des constructions super légères avec une bonne résistance	Für extrem leichte Aluminium-Konstruktionen und hohe Belastbarkeit

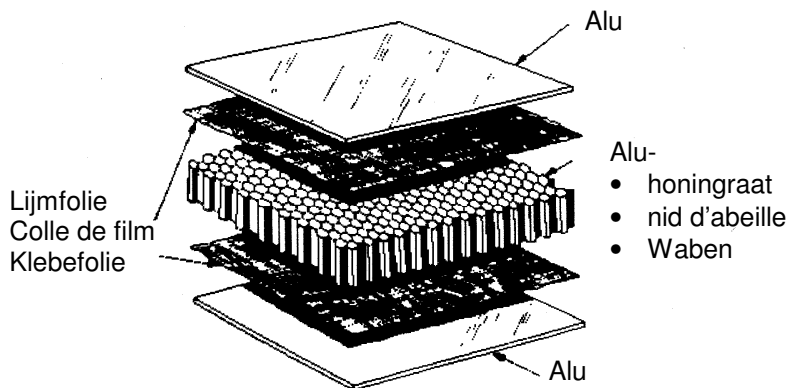

Andere dikte-maten op aanvraag
 Autre epaisseur sur demande
 Andere Dicke auf Anfrage

Dikte d / Epaisseur d / Dicke d	B*L	1250 * 6250	1500 * 6250	Gewicht / Poids / kg/m²
d = 6 mm.		*	1102099	4,9
d = 10 mm.		485210	485510	5,3
d = 15 mm.		485215	485515	7,0
d = 20 mm.		485220	485520	7,4
d = 25 mm.		485225	485525	7,8

Paneeldikten 10 - 15 - 20 - 25 mm.	Épaisseur des panneaux 10 - 15 - 20 - 25 mm.	Paneeldicken 10 - 15 - 20 - 25 mm.
Aluminium dekplaten: Voor paneeldikten: 10 mm Voorzijde: 1,0 mm Achterzijde: 0,5 mm Voor paneeldikten: 15, 20 en 25 mm 2 - zijdig: 1,0 mm	Recouvrement en aluminium Épaisseur de panneau: Face avant: 1,0 mm Face arrière: 0,5 mm Épaisseur de panneau: 15 - 20 - 25 mm 2 - faces: 1,0 mm	Aluminium Deckbleche: Panelstärke: 10 mm Vorderseite: 1,0 mm Rückseite: 0,5 mm Panelstärke 15 - 20 - 25 mm Beidseitig: 1,0 mm
Oppervlakte: standaard: 2 - zijdig wit (gecoilcoat, polyesterlak; met beschermfolie) <u>speciale uitvoeringen (af fabriek):</u> • met kunststoffolie • en krasvaste laklaag	Surface: standaard: 2-faces blanches (laque polyester coil coated + film protecteur) <u>special (sur demande):</u> • Avec film synthétique	Oberfläche: standaard: beidseitig weiss (coilcoated Polyesterlack inklusive Schutzfolie.) <u>speziell (ab Werk lieferbar):</u> • Mit Kunststoff-Folie • Mit kratzfester Lack

Fabrieksvoorraad	Stock d'usine	Werkslager
Paneeldikten: d 10 - 15 - 20 - 25 mm.	Épaisseur des panneaux: d 10 - 15 - 20 - 25 mm.	Panelstärke: d 10 - 15 - 20 - 25 mm.
Breedte: B 1250 en 1500 mm.(max.)	Largeur: B 1250 et 1500 mm.(max.)	Breite: B 1250 und 1500 mm.(max.)
Lengte: L 6250 mm. Andere lengte-maten op aanvraag	Longueur: L 6250 mm. Autres dimensions sur demande	Länge: L 6250 mm. Spezielle Länge-massen auf Anfrage

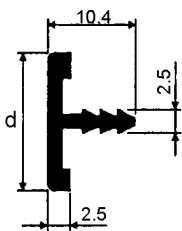

L = 6 m	d (mm.)
AS 41213	6
AS 41214	10
AS 41215	15
AS 41216	20
AS 41217	25

Bewerkingsvoorbeelden
Possibilités de façonnage
Verarbeitungsbeispiele

Buigen Plier Biegen	
Zetten Façonner Kanten	
Drukken Emboutir Pressen	
Frezen Fraiser Fräsen	
Blindklink-montage Fixation Verbinden Befestigen	

Uitgebreide documentatie en advies op aanvraag.
Documentation détaillée et renseignement sur demande.
Ausführliche Dokumentation auf Anfrage

ALUCOBOND®

Sandwichpaneel	Panneaux sandwich	Alu-Verbundplatten
Optimale vlakheid strakheid stijfheid Goed vervormbaarheid Superlicht Dreunarm / geluiddempend	Planéité optimale Stable formé Rigide Bon pour le formage Très léger Assourdi le bruit	Planeben Hohe Biegesteifigkeit Gute verformbarkeit Leicht Schwingungsdämpfend
Toepassing-voorbeelden	Exemples d'usine	Beispiele
Gevelementen Reclameborden. Interieurbouw. Expositie en standbouw Bewegwijzering	Revêtements de façades Panneaux publicitaires Décoration intérieure Pour les stands d'exposition Signalisation	Fassaden Werbungspaneelen Innenarchitektur Messebau Straßenmarkierung

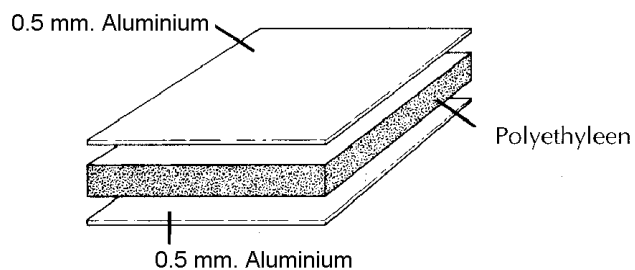

Dikte	Gewicht
Épaisseur	Poids
Dicke	Gewicht
3 mm	4,5 kg/m ²
4 mm	5,5 kg/m ²
6 mm	7,3 kg/m ²

Paneeldikten: 2, 3, 4, 6 mm.	Épaisseurs de panneau: 2, 3, 4, 6 mm.	Panelstärke: 2, 3, 4, 6 mm.
Plaattypen: <ul style="list-style-type: none"> • Blank • Gemoffeld • Geanodiseerd 	Surface: <ul style="list-style-type: none"> • Brut • Laqué • Anodisé 	Oberfläche: <ul style="list-style-type: none"> • Walzmatt • Lakiert • Eloxiert

Via fabriek op aanvraag	Départ usine	Ab Werk lieferbar
Paneeldikten: 3, 4, 6 mm.	Épaisseurs de panneau: 3, 4, 6 mm.	Panelstärke: 3, 4, 6 mm.
Breedte: 1000, 1250 en 1500 mm	Largeur: 1000, 1250 en 1500 mm	Breite: 1000, 1250 en 1500 mm
Lengte: Max. 8000 mm.	Longueur: Max. 8000 mm.	Länge: Max. 8000 mm.

Uitgebreide documentatie en advies op aanvraag.
Documentation détaillée et renseignement sur demande.
Ausführliche Dokumentation auf Anfrage

DIBOND®

Sandwichpaneel	Panneaux de sandwich	Alu-Verbundplatten
Licht en sterk Stabiel van vorm Goed vervormbaar Duurzaam Bestand tegen weersinvloeden UV- bestendig	Léger et solide Stable formé Bon pour le formage Bonne tenue dans le temps Résistant aux changement de temps Résistant aux UV	Leicht und Stark Formstabil Höhe Verformbarkeit Dauerhaft Witterungsbeständig UV-unempfindlich
Toepassing-voorbeelden	Exemples d'usine	Beispiele
Reclameborden. Interieurbouw. Expositie en standbouw. Bewegwijzering	Panneaux publicitaires Décoration intérieure Pour les stands d'exposition Signalisation	Display und Werbe-Paneele Interieurbau. Messestandbau Auskunft- Verkehrsschild.

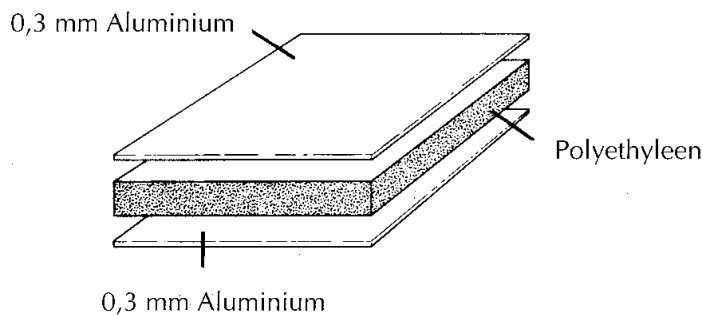

Dikte Épaisseur Dicke	Gewicht Poids Gewicht
2 mm	2,90 kg/m ²
3 mm	3,80 kg/m ²
4 mm	4,75 kg/m ²
6 mm	6,70 kg/m ²

Paneeldikten: 2, 3, 4 mm.	Épaisseurs de panneau: 2, 3, 4 mm.	Panelstärke: 2, 3, 4 mm.
Plaattypen: <ul style="list-style-type: none"> Gemoffeld: wit, alumetallic, zwart, blauw, rood "Butlerfinish" (=RVS-look) 	Surface: <ul style="list-style-type: none"> Laqué: blanc, métallique aluminium, noir, bleu, rouge "Butlerfinish" (=INOX-look) 	Oberfläche: <ul style="list-style-type: none"> Lakiert: weiss, Alu-Metallic, schwarz, blau, rot "Butlerfinish" (=Inox-look)

Via fabriek op aanvraag	Départ usine	Ab Werk lieferbar
Paneeldikten: 2, 3, 4, 6 mm.	Épaisseurs de panneau: 2, 3, 4, 6 mm.	Panelstärke: 2, 3, 4, 6 mm.
Breedte: 1000, 1250 en 1500 mm	Largeur: 1000, 1250 en 1500 mm	Breite: 1000, 1250 en 1500 mm
Lengte: 2050-2500-3050-4050-5050-6250 mm.	Longueur: 2050-2500-3050-4050-5050-6250 mm.	Länge: 2050-2500-3050-4050-5050-6250 mm.

Uitgebreide documentatie en advies op aanvraag.
Documentation détaillée et renseignement sur demande.
Ausführliche Dokumentation auf Anfrage

Hulpprofielen

Profils d'assemblage 3 – 4 mm.

Montageprofilen

D-1-7

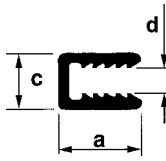

d (mm.)	a (mm.)	c (mm.)	Nr.	kg/m	code	L
3	10,5	7	AS 24554	0,11	330702	6,00 m
4	13,5	8	AS 24494	0,14	330704	6,00 m
6	20	11	AS 24561	0,26	330708	6,00 m

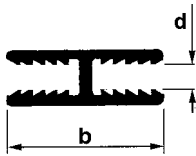

d (mm.)	b (mm.)	Nr.	kg/m	code	L
3	19,5	AS 24555	0,20	330722	6,00 m
4	25,5	AS 24551	0,25	330724	6,00 m
6	38	AS 24562	0,47	330728	6,00 m

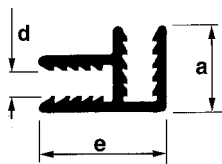

d (mm.)	a (mm.)	e (mm.)	Nr.	kg/m	code	L
3	10,5	16	AS 24556	0,19	330742	6,00 m
4	13,5	20	AS 24552	0,25	330744	6,00 m
6	20	29	AS 24563	0,49	330748	6,00 m

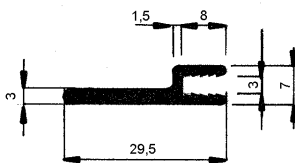

FL 09548
0,26 kg/m
code
330738 6,00 m

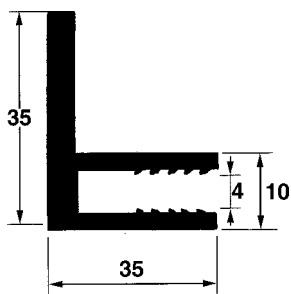

AS 31601
0,81 kg/m
code
330776 6,00 m

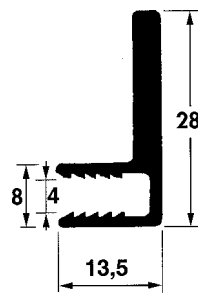

AS 24493
0,37 kg/m
code
330775 6,00 m

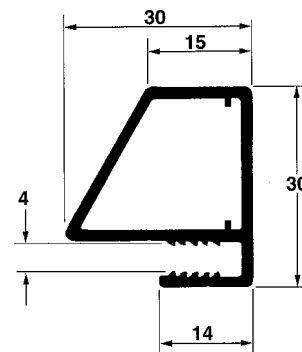

AS 28335
0,59 kg/m
code
330737 6,00 m

Klemstijl met toebehoren

Profile de clamage avec accessoires

Klemprofil mit Zubehör

D-1-8

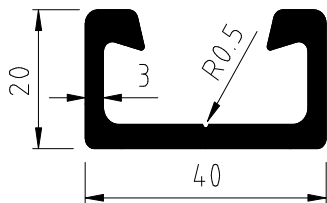

FL 10255
 0,82 kg/m
 code
384015 7,20 m Anod

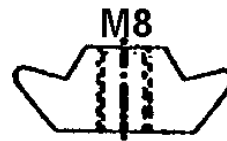

AN 759
 0,02 kg/st-pc
 code
646070

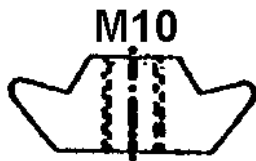

AG 6422-90
 0,02 kg/st-pc
 code
646069

Voorbeeld montage
 Exemple de montage
 Montage Beispiel

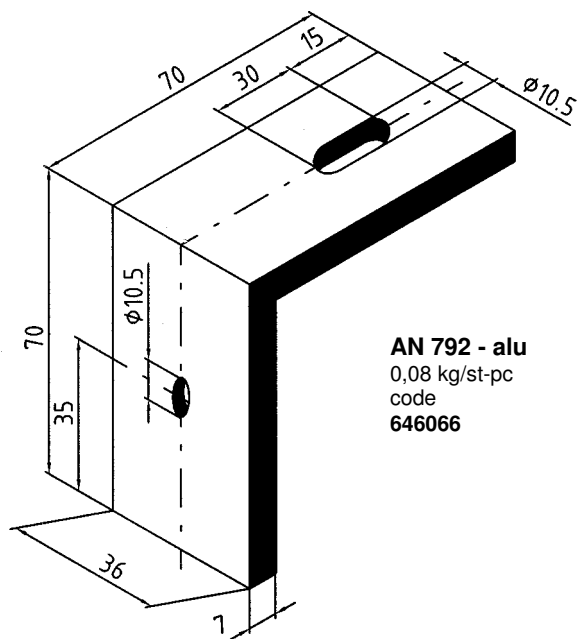

AN 792 - alu
 0,08 kg/st-pc
 code
646066

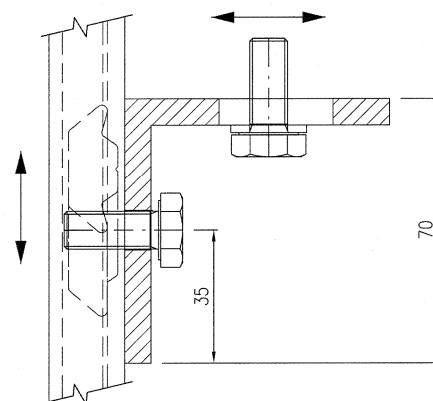
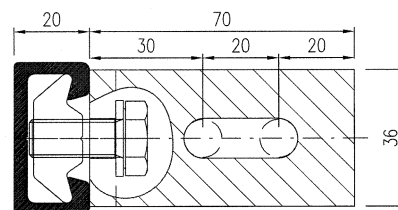

Alu klepscharnier
Charnières-alu de porte
Alu-Scharnieren

D-1-9

AL 12351

0,78 kg/m

Code

1100685

7,60 m Anod.

1100585

7,60 m

AL 12350

0,61 kg/m

code

1100684

7,60 m Anod.

1100584

7,60 m

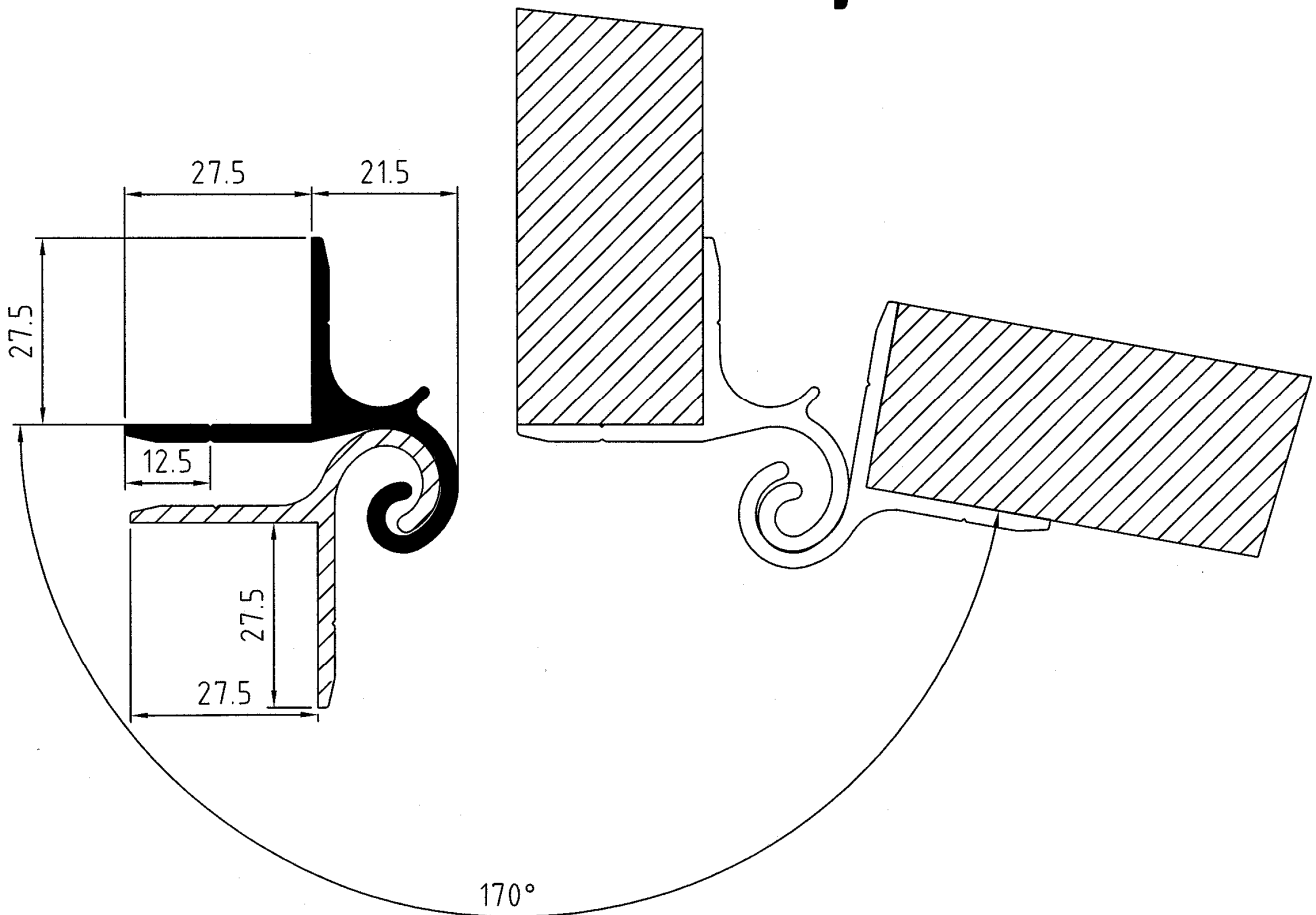
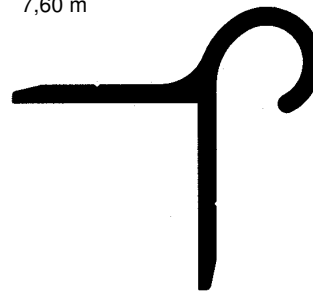
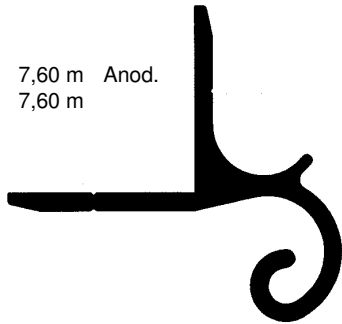

Gesloten opbouw
Fourgon
Kastenwagen

C3000



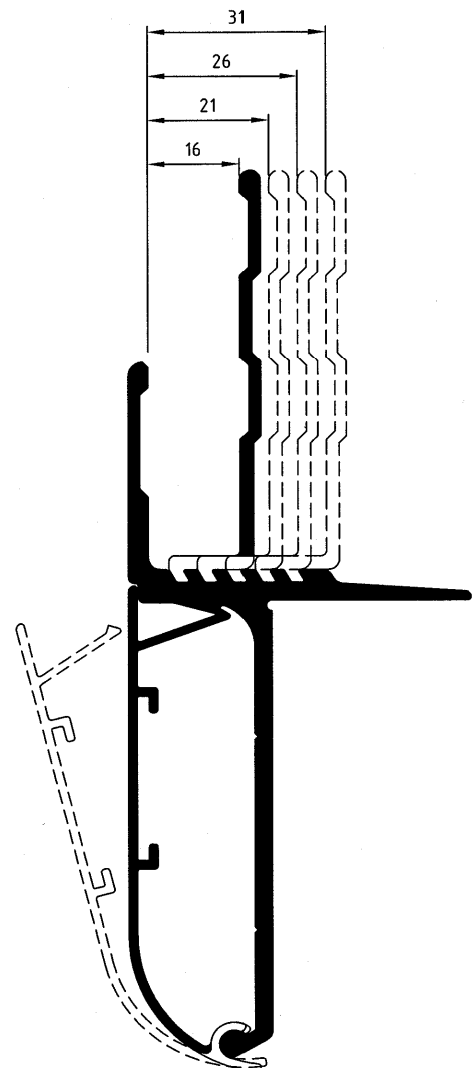
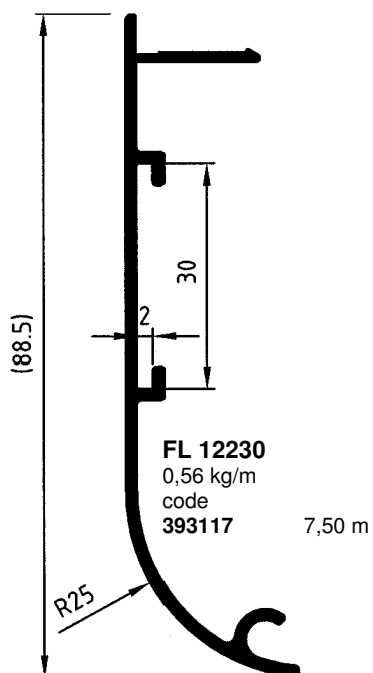
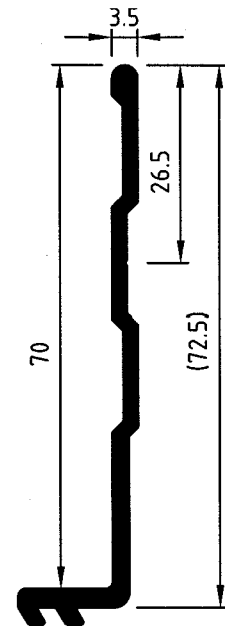
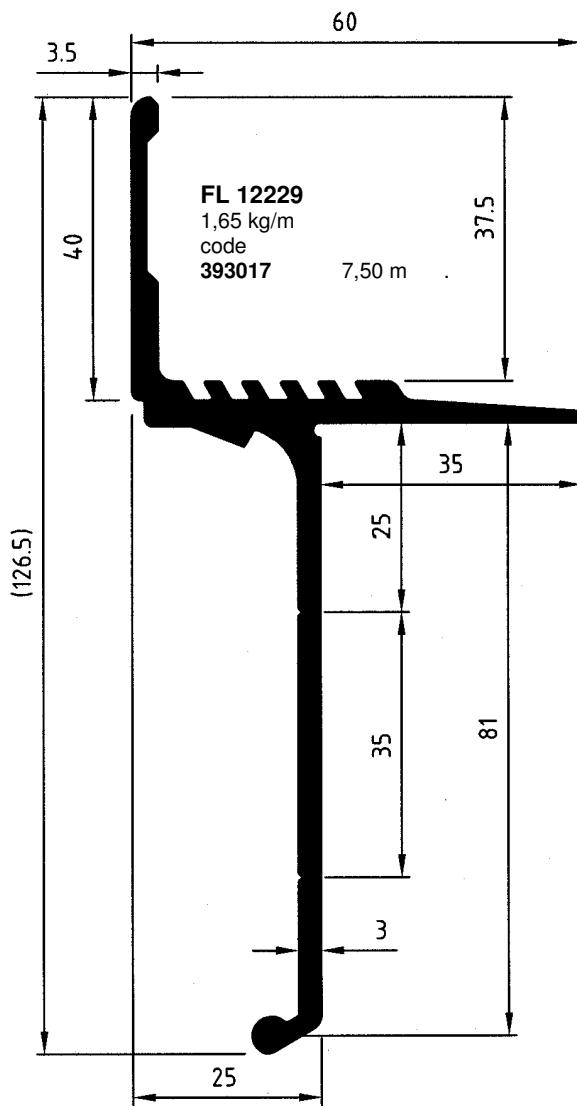







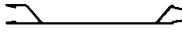
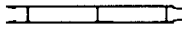





D-1-10

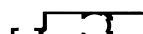

**Gesloten opbouw
Fourgon
Kastenwagen**

20 mm

D-2-1

Blz. Page Seite	Profiel nr. Nr. de profil Profil Nr.	Gewicht Poids Gewicht	Symbool Symbole Symbol	Beschrijving Description Bezeichnung	Lengte Longueur Länge
D-2-2	FL 05219	2,78 kg/m		Onderrandprofiel Rive inférieure Untergurtprofil	7,50 m 13,50m
	FL 04565	1,55 kg/m (7,75 kg/m ²)		Zijwandprofiel Profilé de paroi Seitenwandprofil	*
	FL 21424	2,54 kg/m (12,70 kg/m ²)			7,00 m 7,50 m
D-2-3	FL 21721	2,14 kg/m		Bovenrandprofiel Profilé supérieur Oberes Randprofil	7,50 m 13,50m
	FL 03291	0,90 kg/m		Koptoog Traverse/toiture Dachspriegelprofil	5,00 m
	CH 51612	0,42 kg/m		Klemprofiel plaat Profilé de tôles Montageprofil Blech	4,50 m
	FL 21991	2,14 kg/m		Hoekprofiel Profilé de coin Eckprofil	5,00 m 6,00 m
	AG 3654-08	0,31 kg/st-p		Kapbol (lasbaar) Calotte (à souder) Eckkalotte (Schweisssbar)	
	AG 5480-06	0,27 kg/st-p		Kapbol (verlijmen) Calotte (à coller) Eckkalotte (Verkleben)	
D-2-4	FL 05737	0,98 kg/m		Deurprofiel Profilé de porte Türrahmenprofil	6,50 m
	FL 05738	1,33 kg/m			6,50 m
	FL 26494	1,87 kg/m			6,50 m
	AN 899	0,15 kg/m		Rubberprofiel Joint Dichtgummi	50 m
	AN 625	0,15 kg/m			50 m
	AN 502	0,20 kg/m			50 m
D-2-5	AN 579	2,52 kg/m		Scharnier compleet Charnière complète Scharnier Komplett	2,40 m 3,00 m
	FL 06625	0,99 kg/m		Deurprofiel Profilé de porte Türrahmenprofil	6,50 m
	FL 06443	0,80 kg/m			6,50 m
	FL 22427	1,83 kg/m		Deurprofiel Profilé de porte Türrahmenprofil	6,50 m
	AN 575	0,56 kg/m		Rubberprofiel Joint Dichtgummi	6,50 m

**Gesloten opbouw
Fourgon
Kastenwagen**

20 mm

D-2-2

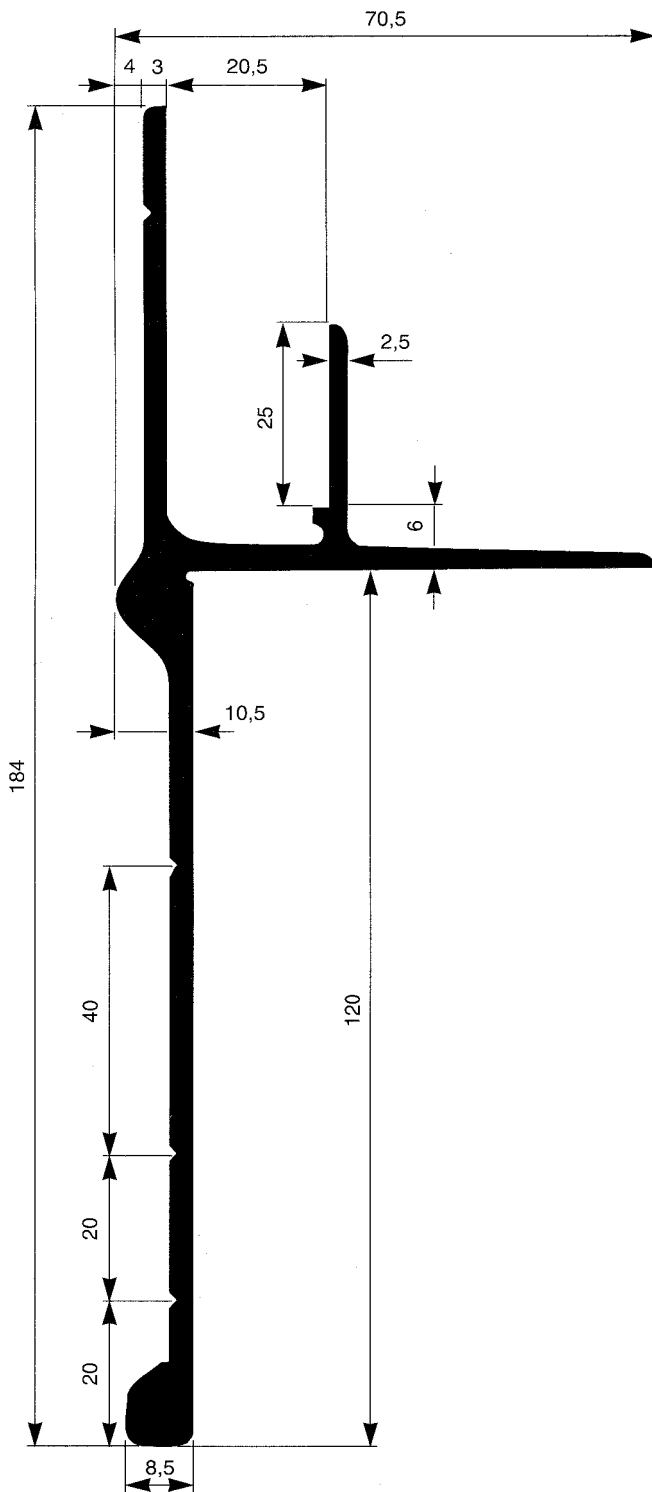

FL 05219

2,78 kg/m

code

432317

7,50 m

432342

13,50 m

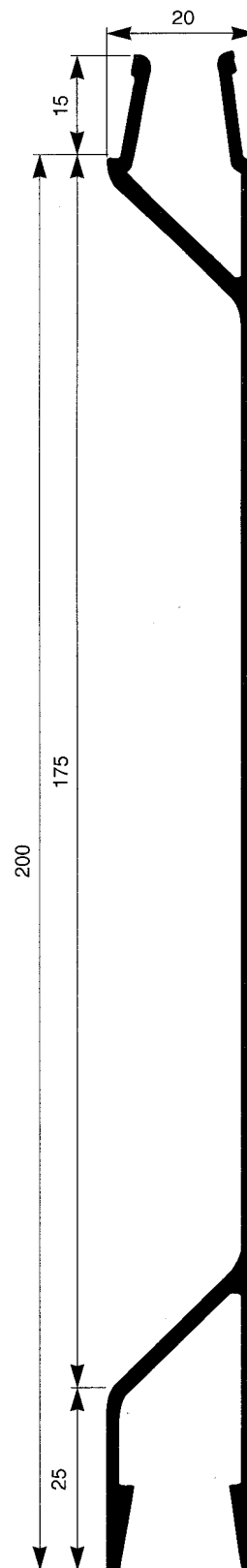

FL 04565

1,55 kg/m

*

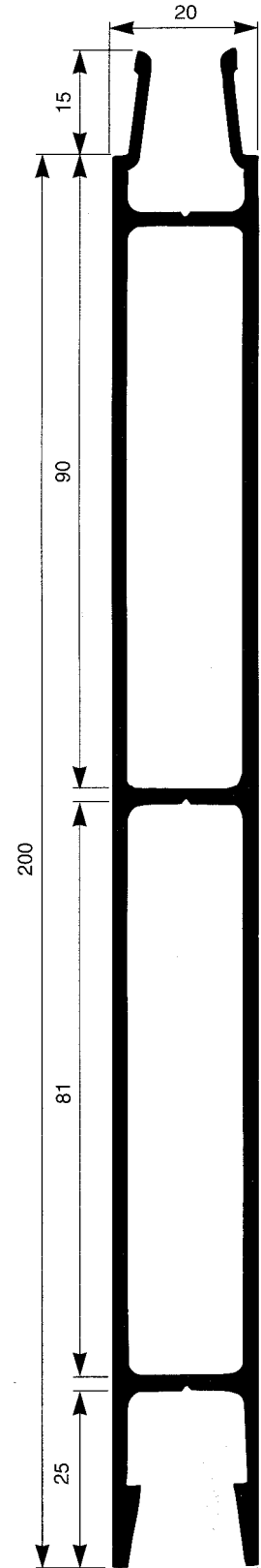

FL 21424

2,54 kg/m

code

1102208

7,00 m

431517

7,50 m

**Gesloten opbouw
Fourgon
Kastenwagen**

D-2-3

20 mm

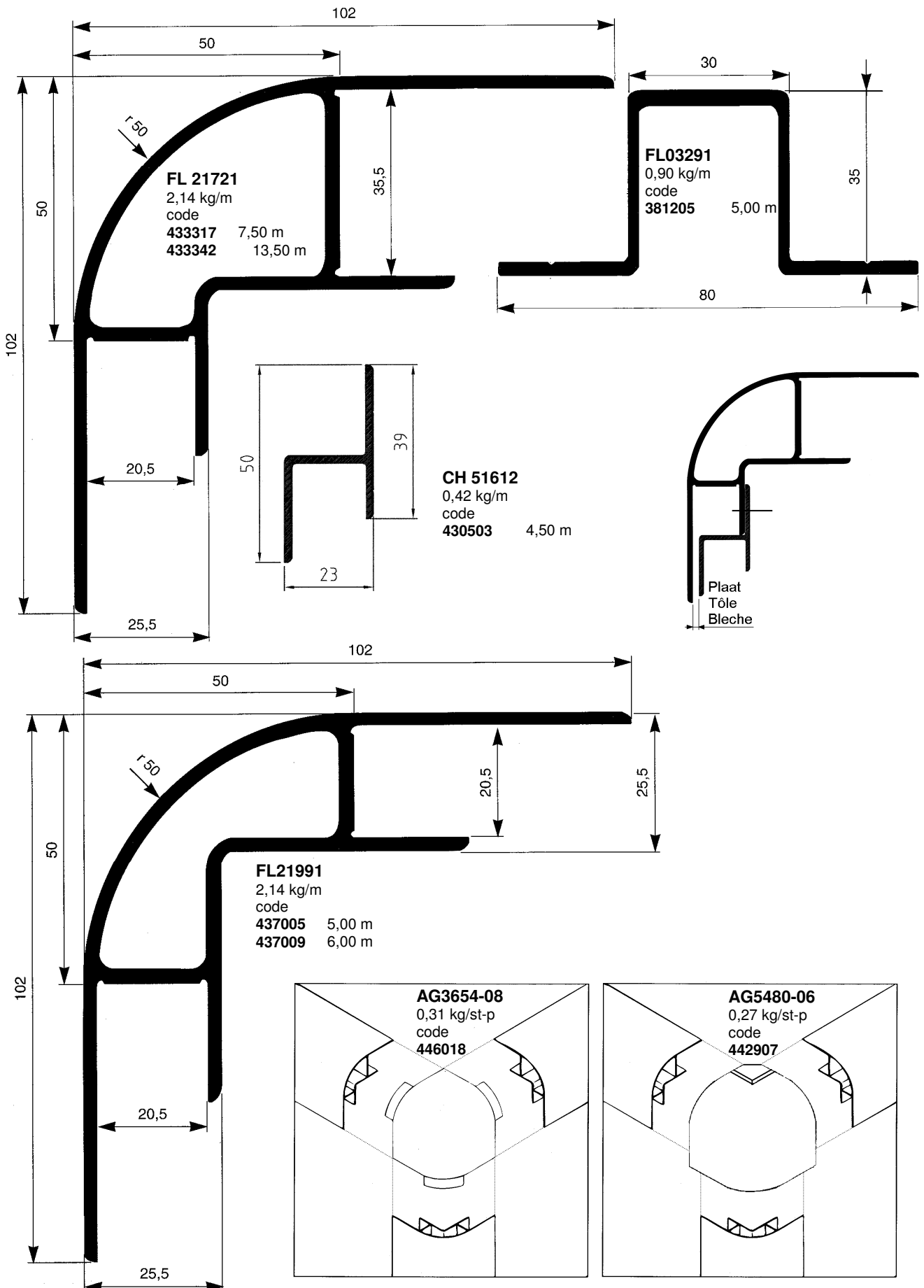

**Gesloten opbouw
Fourgon
Kastenwagen**

20 mm

D-2-4

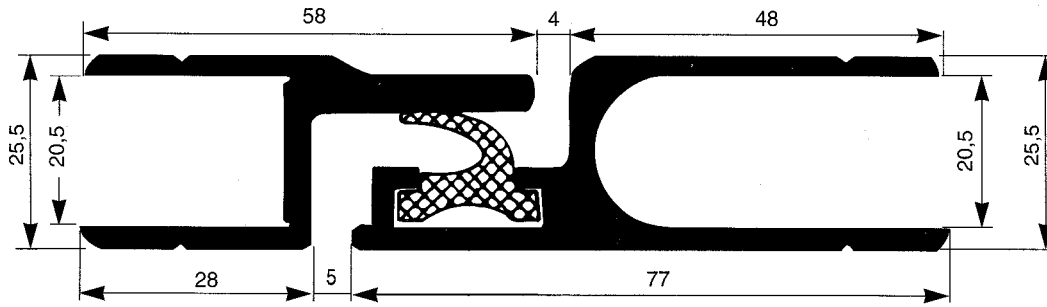

FL 05737
0,98 kg/m
code
435511 6.50 m

FL 05738
1,33 kg/m
code
435611 6.50 m

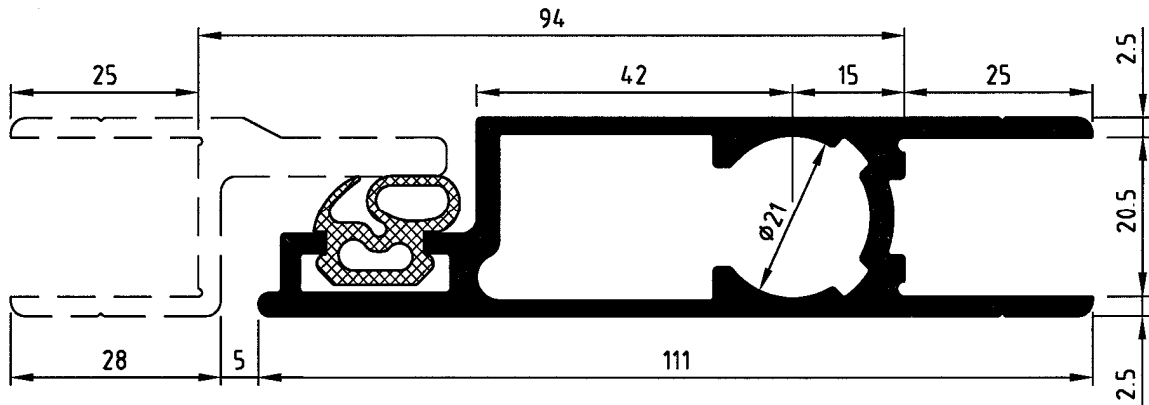

FL 26494
1,87 kg/m
code
435811 6.50 m

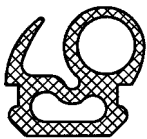

AN 625
0,15 kg/m
code
646101 50 m

**Of
Ou
Oder**

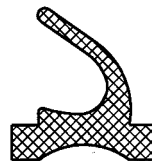

AN 502
0,20 kg/m
code
444010 50 m

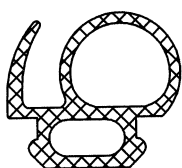

AN 899
0,15 kg/m
code
646102 50 m

**Gesloten opbouw
Fourgon
Kastenwagen**

20 mm

D-2-5

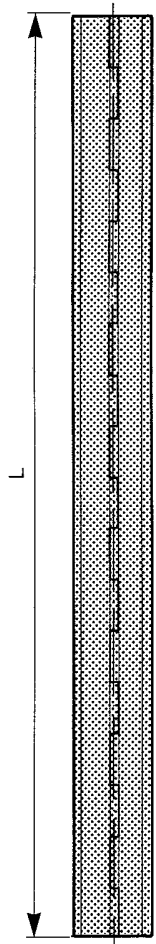
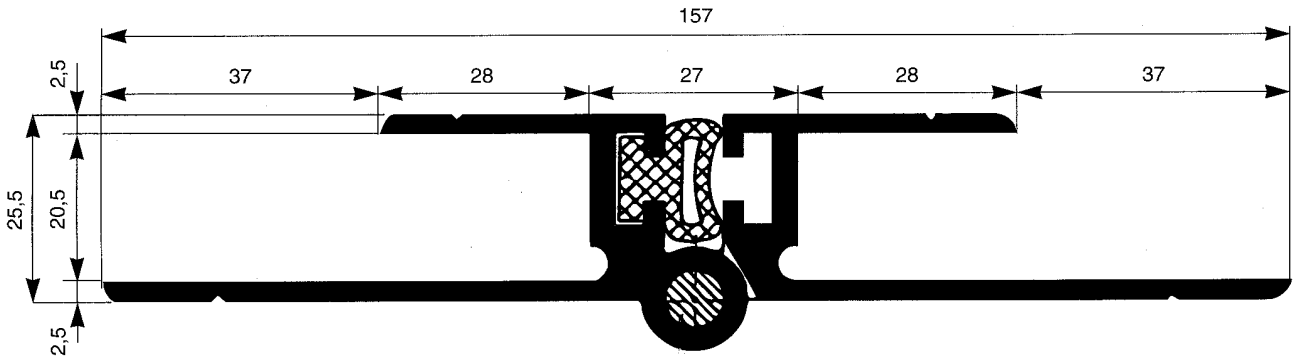

AN 579
2,52 kg/m
code
448340
448380

Kunststof as
Axe synthétique
Kunststoff Achse
L= 2400 mm
L= 3000 mm

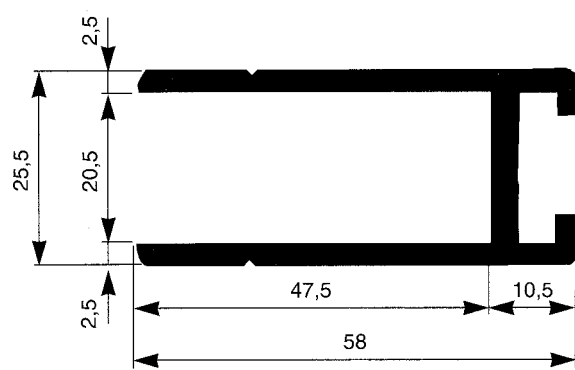

FL 06625
0,99 kg/m
code
435311 6,50 m

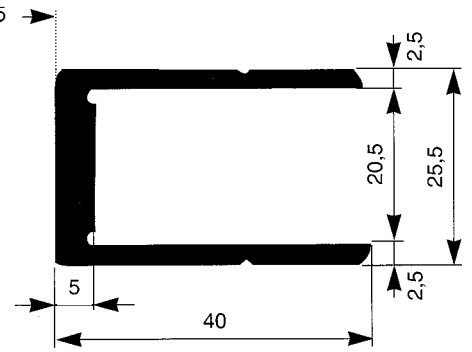

FL 06443
0,80 kg/m
code
435111 6,50 m

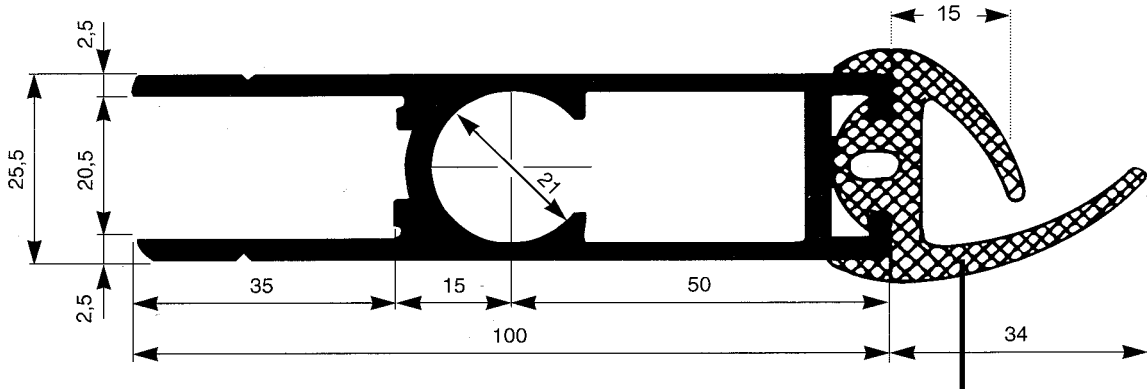

FL 22427
1,83 kg/m
code
435211 6,50 m

AN 575
0,56 kg/m
code
444055 6,50 m

**Gesloten opbouw
Fourgon
Kastenwagen**

25 mm











D-3-1

Blz. Page Seite	Profiel nr. Nr. de profil Profil Nr.	Gewicht Poids Gewicht	Symbool Symbole Symbol	Beschrijving Description Bezeichnung	Lengte Longueur Länge
D-3-3	FL 20517	2,09 kg/m		Bovenrandprofiel Profilé supérieur Oberes Randprofil	7,50 m 13,50m
	FL 03291	0,90 kg/m		Kaptraag Traverse/toiture Dachspriegelprofil	5,00 m
	FL 21059	1,78 kg/m		Stijlprofiel Profilé de montant Pfostenprofil	7,50 m
	FL 05824	0,60 kg/m		Bindlijst Profilé d'arrimage Bindleisteprofil	*
	FL 04844	2,65 kg/m		Onderrandprofiel Rive inférieure Untergurtprofil	7,50 m 13,50m
D-3-4	FL 25274	2,20 kg/m		Hoekprofiel Profilé de coin Eckprofil	7,50 m
	CH 47066	0,21 kg/m		Afwerkprofiel Profilé de finition Deckleiste	5,00 m
	FL 03815	0,22 kg/m		Regengootprofiel	5,00 m
	AG 3654-08	0,30 kg/st-p		Kapbol (lasbaar) Calotte (à souder) Eckkalotte (Schweisssbar)	
	AG 5480-06	0,27 kg/st-p		Kapbol (verlijmen) Calotte (à coller) Eckkalotte (Verkleben)	
D-3-5	FL 07096	1,60 kg/m		Bovenrandprofiel Profilé supérieur Oberes Randprofil	*
	FL 02240	1,04 kg/m		Deurprofiel Profilé de porte Türrahmenprofil	6,00 m
	AN 575	0,56 kg/m		Rubberprofiel Joint Dichtgummi	6,50 m
	DC 08220	1,66 kg/m		Deurprofiel Profilé de porte Türrahmenprofil	
	FL 07313	1,04 kg/m			6,50 m
	FL 02241	0,71 kg/m			6,00 m
	FL 05806	1,42 kg/m		Onderrandprofiel Rive inférieure Untergurtprofil	7,50 m
D-3-6	AN 584	2,53 kg/m		Scharnier compleet Charnière complète	2,40 m 3,00 m
	AN 825	2,93 kg/m		Scharnier Komplett	2,40 m 2,80 m 3,00 m
	FL 07689	1,11 kg/m		Deurprofiel Profilé de porte Türrahmenprofil	6,50 m
	FL 06937	1,00 kg/m			6,50 m

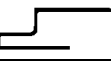
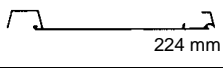
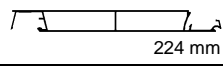
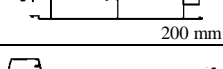
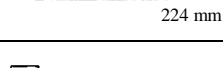
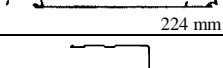

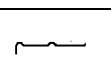

**Gesloten opbouw
Fourgon
Kastenwagen**

25 mm

D-3-2

Blz. Page Seite	Profiel nr. Nr. de profil Profil Nr.	Gewicht Poids Gewicht	Symbool Symbole Symbol	Beschrijving Description Bezeichnung	Lengte Longueur Länge
D-3-6	AN 625	0,15 kg/m			50 m
	AN 899	0,15 kg/m		Rubberprofiel Joint Dichtgummi	50 m
	AN 502	0,20 kg/m			50 m
	FL 01494	0,98 kg/m		Deurprofiel Profilé de porte	6,50 m
	FL 01495	1,24 kg/m		Türrahmenprofiel	6,50 m
D-3-7	FL 60311	1,77 kg/m (7,81 kg/m ²)		Enkelwandig profiel Profilé de paroi-single Wandprofiel Enkel	blank Brute Roh
	FL 27677 FL 29272	2,87 kg/m (12,81 kg/m ²)		dubbelwandig profiel Profilé de paroi-double Wandprofiel Doppel	primer Pre- laqué Primär
D-3-8	DC 10160	2,30 kg/m (11,5 kg/m ²)		Wandprofiel Doppel	7,50 m
	DC 07908	2,10 kg/m (9,37 kg/m ²)		Enkelwandig profiel Profilé de single paroi	5,60 m 6,70 m 7,50 m
	DC 10015	2,70 kg/m (12,05 kg/m ²)		Wandprofiel Enkel	
D-3-9	DC 08087	1,09 kg/m		Randprofiel	
	FL 03563	0,35 kg/m		Rive Gurtprofiel	6,00 m
	FL 03564	0,75 kg/m			6,00 m
	AL 42131	0,90 kg/m			7,80 m
	DC 07879	1,80 kg/m		Onderrandprofiel Rive inférieure Untergurtprofiel	
	AN 879	0,10 kg/m		Afdekprofiel rubber Galon caoutchouc Deckprofiel gummi	

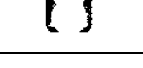
Op aanvraag / sur demande / auf Anfrage

	FL 26637	1,56 kg/m		Deurprofiel Profilé de porte	*
	FL 26638	1,59 kg/m		Türrahmenprofiel	*
	AL 12345	1,08 kg/m		Deurprofiel Profilé de porte Türrahmenprofiel	*
	FL 11002	1,62 kg/m		Deurprofiel Profilé de porte Türrahmenprofiel	*
	AN 757	0,18 kg/m		Rubberprofiel Joint Dichtgummi	50 m

**Gesloten opbouw
Fourgon
Kastenwagen**

25 mm

D-3-3

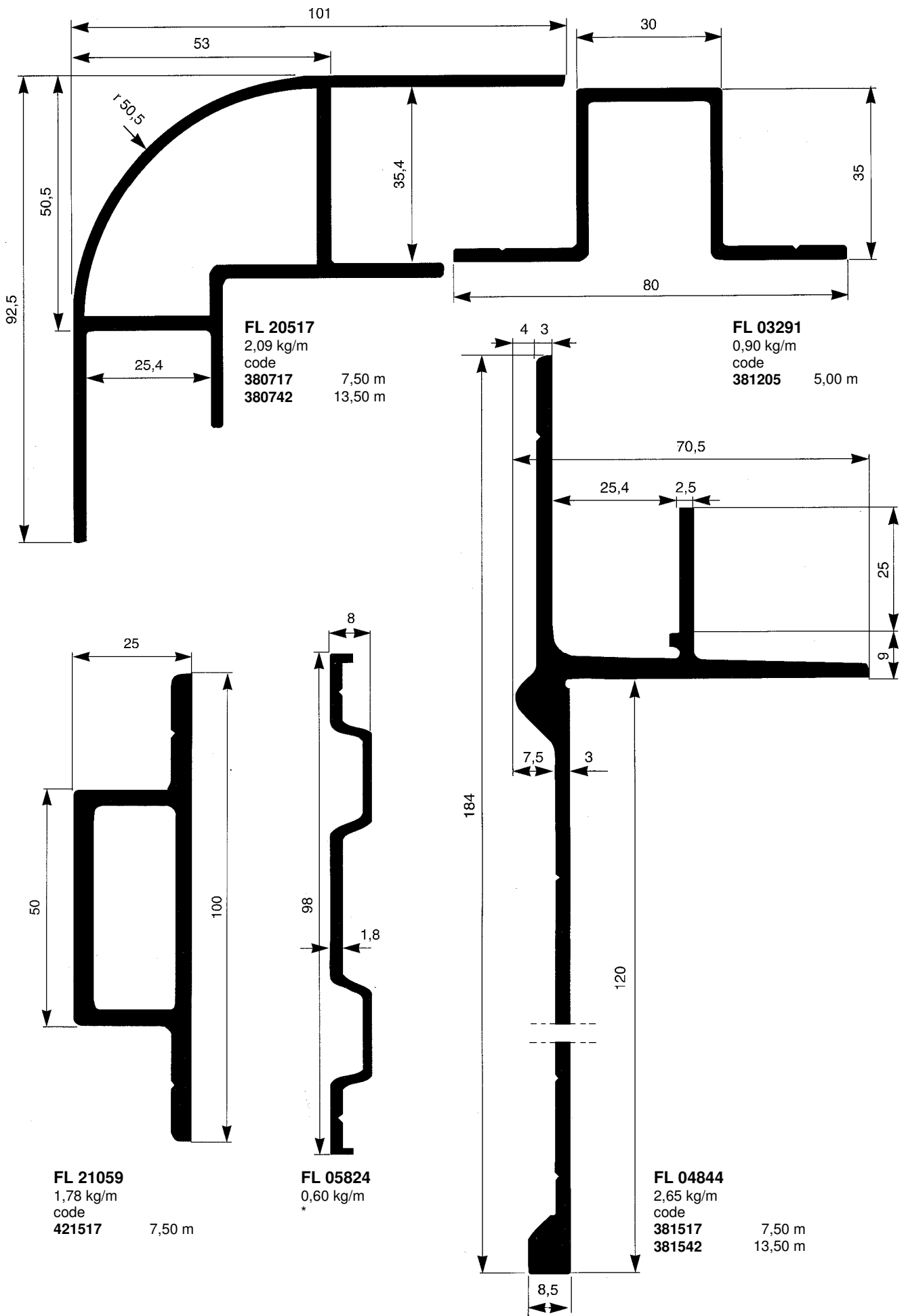

**Gesloten opbouw
Fourgon
Kastenwagen**

D-3-4

25 mm

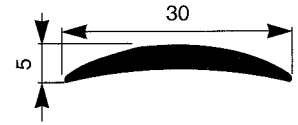
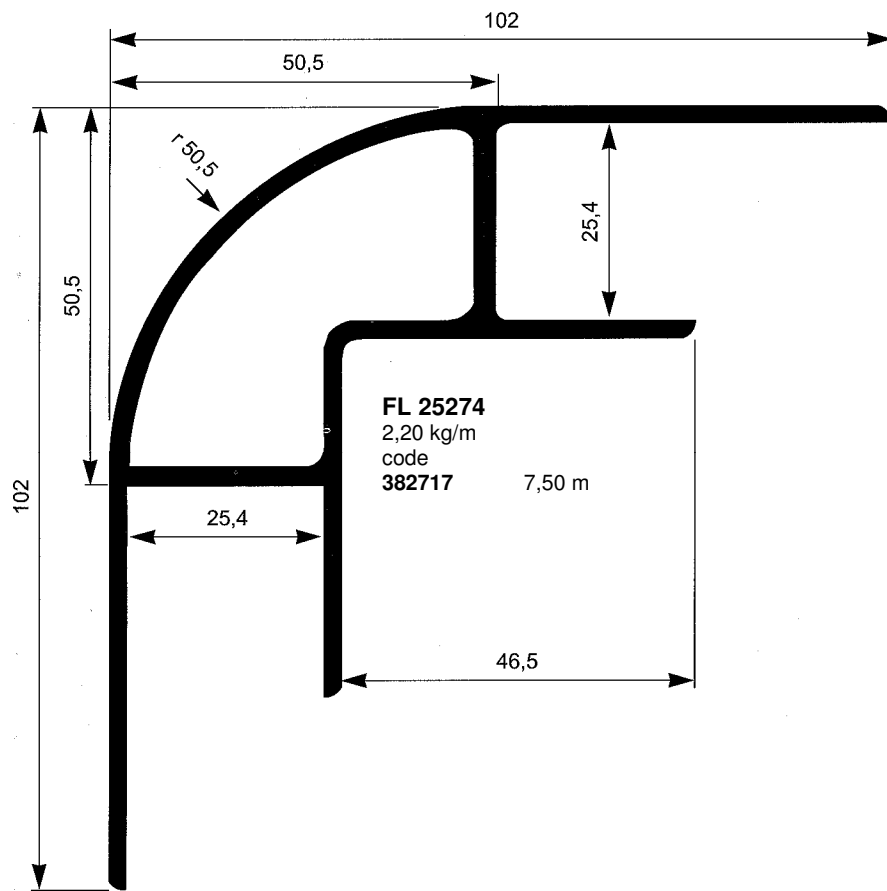

CH 47066
0,21 kg/m
code
331114 5,00 m

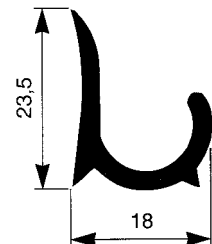

FL 03815
0,22 kg/m
code
331130 5,00 m

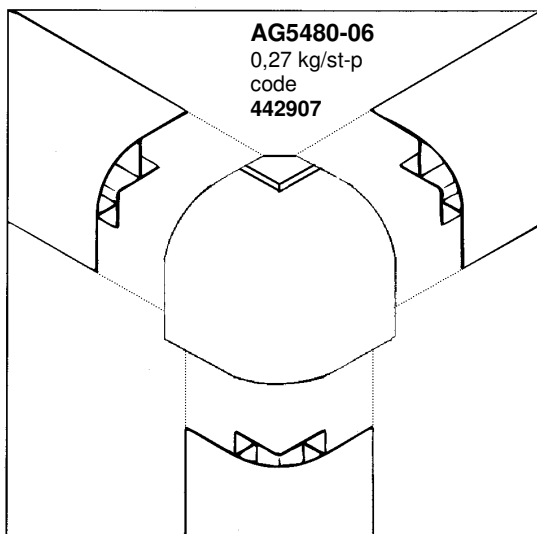

AG5480-06
0,27 kg/st-p
code
442907

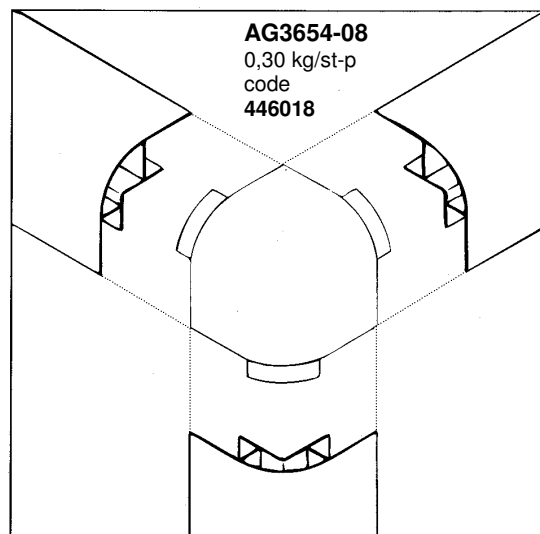

AG3654-08
0,30 kg/st-p
code
446018

**Gesloten opbouw
Fourgon
Kastenwagen**

25 mm

D-3-5

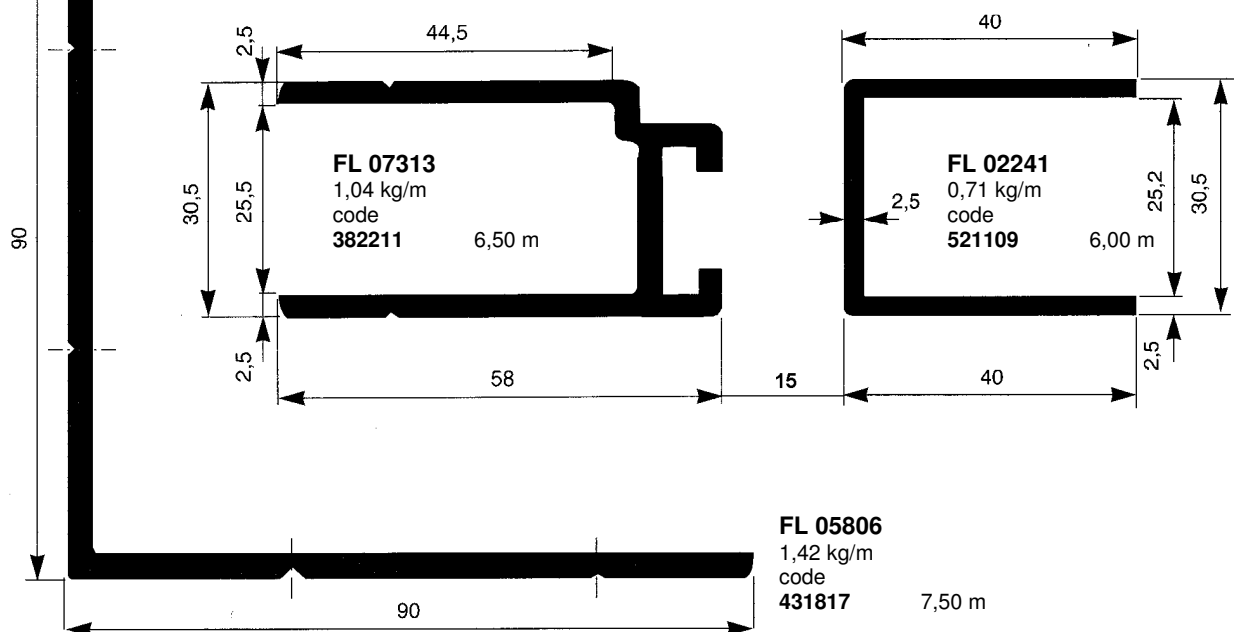
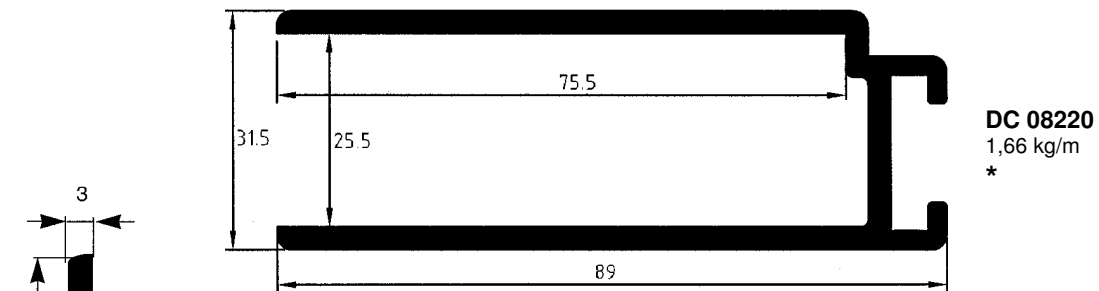
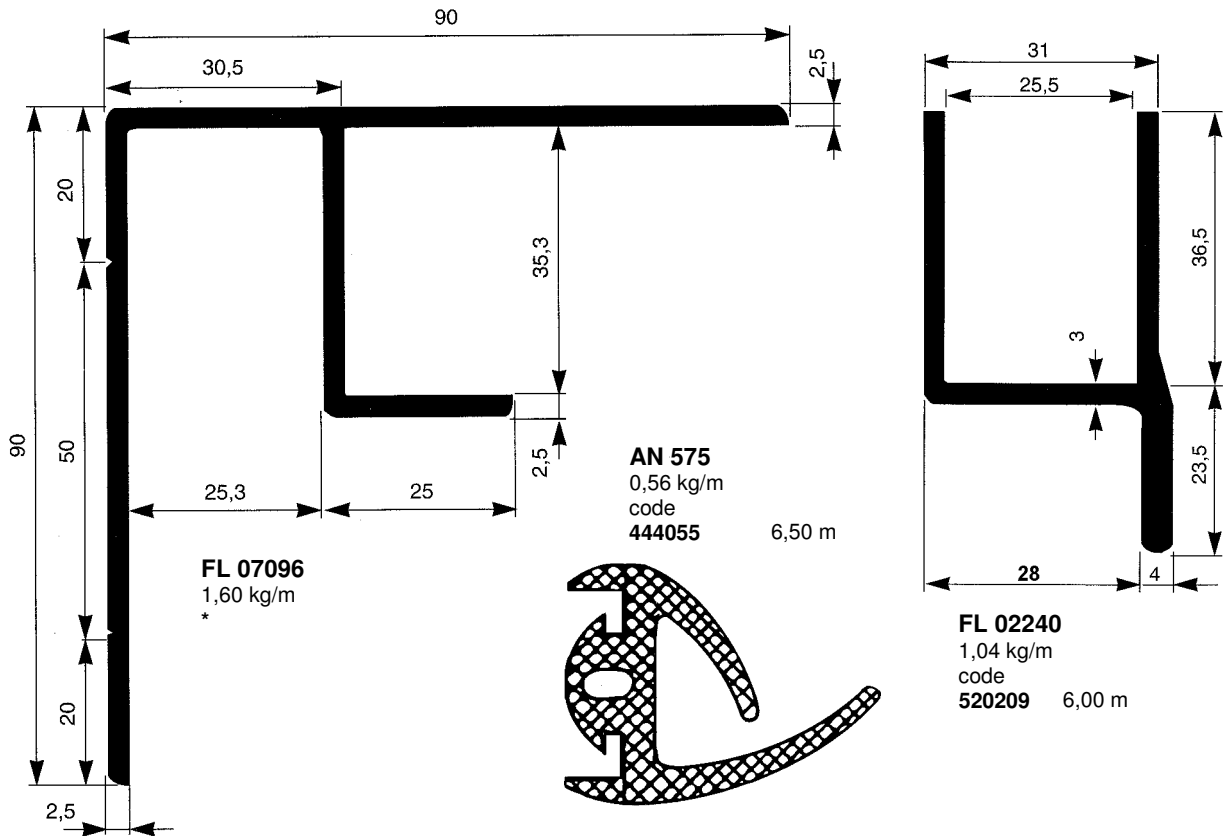

**Gesloten opbouw
Fourgon
Kastenwagen**

D-3-6

25 mm

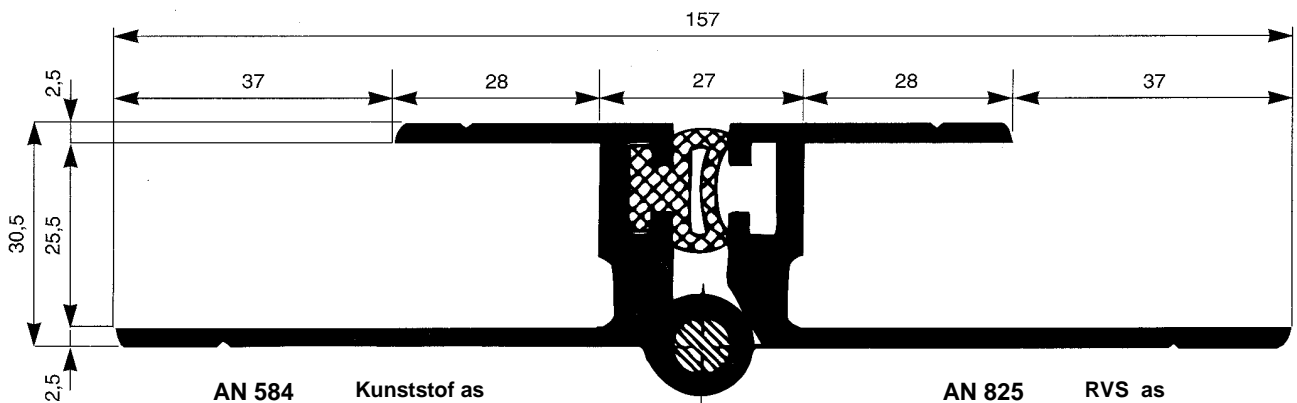

AN 584
2,53 kg/m
code
448540
448580

Kunststof as
Axe synthétique
Kunststoff Achse
L= 2400 mm
L= 3000 mm

AN 825
2,93 kg/m
code
449340
449460
449380

RVS as
Axe inox
Inox Achse
L= 2400 mm
L= 2800 mm
L= 3000 mm



Scharnier smeren met RENAX-AS
Graisser l'axe avec RENAX-AS
Scharnier smieren mit RENAX-AS

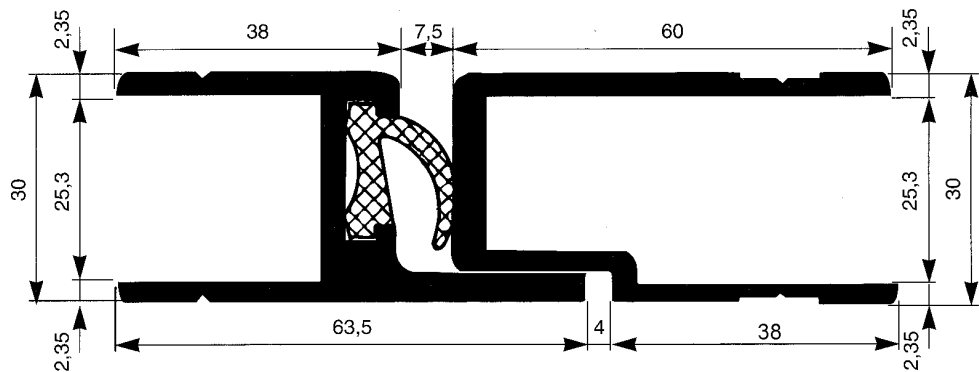
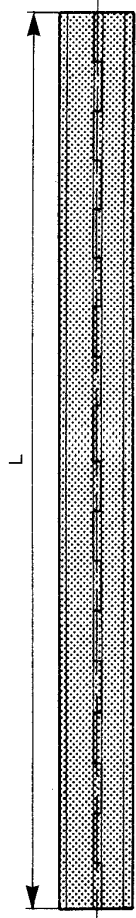

FL 07689
1,13 kg/m
code
380711

6,50 m

FL 06937
1,00 kg/m
code
363211

6,50 m

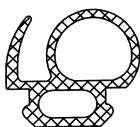

AN 899
0,15 kg/m
code
646102

50 m

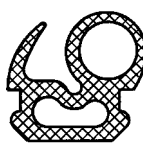

AN 625
0,15 kg/m
code
646101

50 m

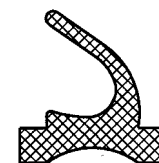

AN 502
0,20 kg/m
code
444010

50 m

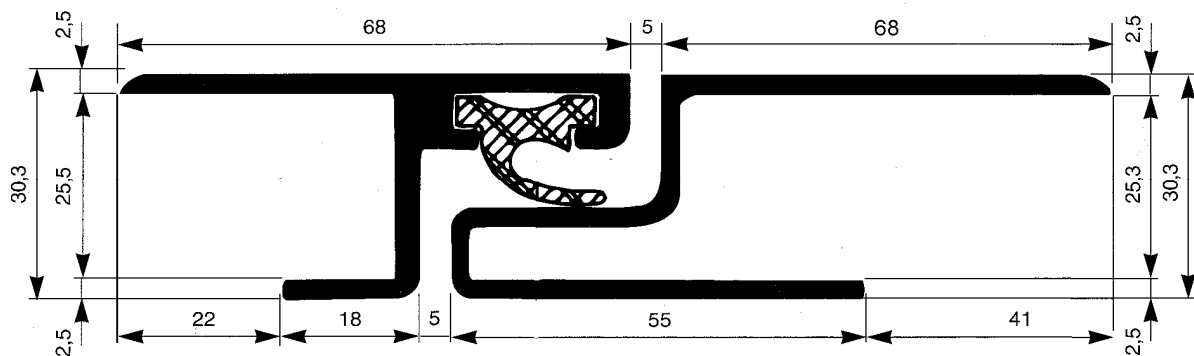

FL 01494
0,98 kg/m
code
380211

6,50 m

FL 01495
1,24 kg/m
code
380311

6,50 m

**Gesloten opbouw
Fourgon
Kastenwagen**

25 mm

D-3-7

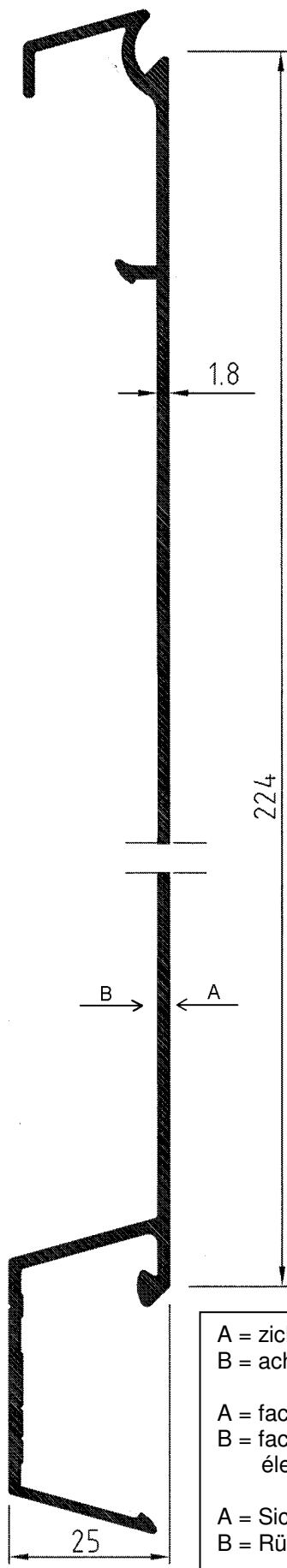

FL 60311 Blank
1,77 kg/m Brute
code Roh
387489 2600 mm
387408 5600 mm
387415 7000 mm
387417 7500 mm

FL 60311 Primer
1,77 kg/m Pré-laqué
code Primär
387890 2600 mm
387807 5600 mm
387815 7000 mm

Overige lengtematen op aanvraag.

Autres dimensions-longue livrable sur demande

Andere Länge Lieferbar auf Anfrage

A = zichtzijde in primer.
B = achterzijde laknevel.

A = face avant pré Laque.
B = face arrière un retour électrostatique de poudre .

A = Sichtseite in Primär.
B = Rückseite Spritznebel

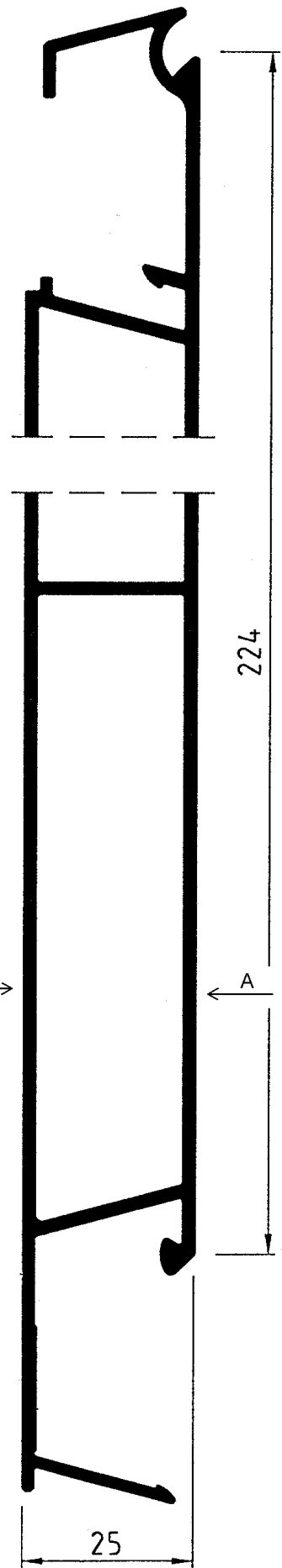

FL 27677 Blank
2,87 kg/m Brute
code Roh
384889 2600 mm
384887 3000 mm
384807 5600 mm
384815 7000 mm

FL 29272 Primer
2,87 kg/m Pré-laqué
code Primär
389889 2600 mm
389887 3000 mm
389807 5600 mm
1102622 7000 mm

Overige lengtematen op aanvraag.

Autres dimensions-longue livrable sur demande

Andere Länge Lieferbar auf Anfrage

Gesloten opbouw
Fourgon
Kastenwagen

25 mm

D-3-8

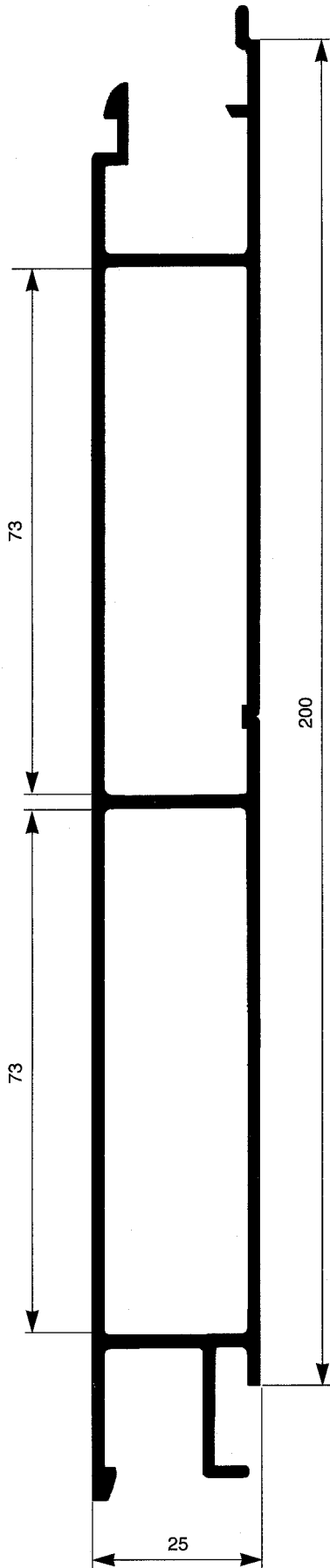

DC 10160
2,30 kg/m
Code
1100173 7,50 m

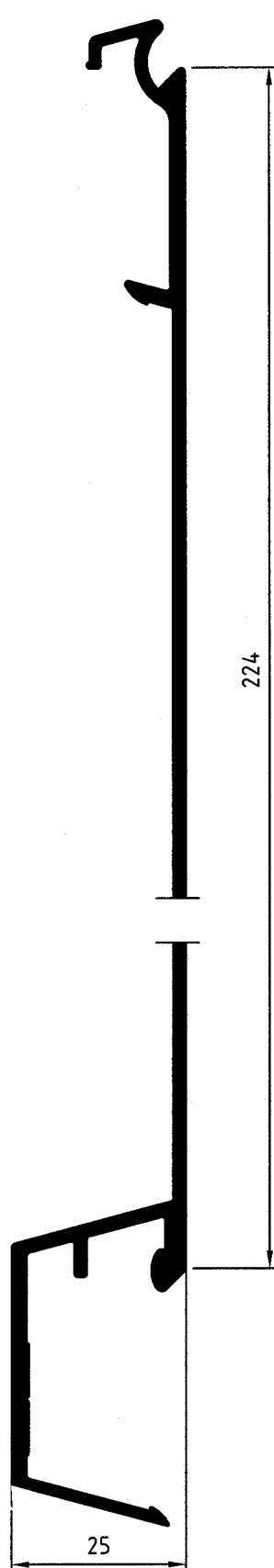

DC 07908
2,10 kg/m
Code
1100133 5,60 m
1100171 7,50 m

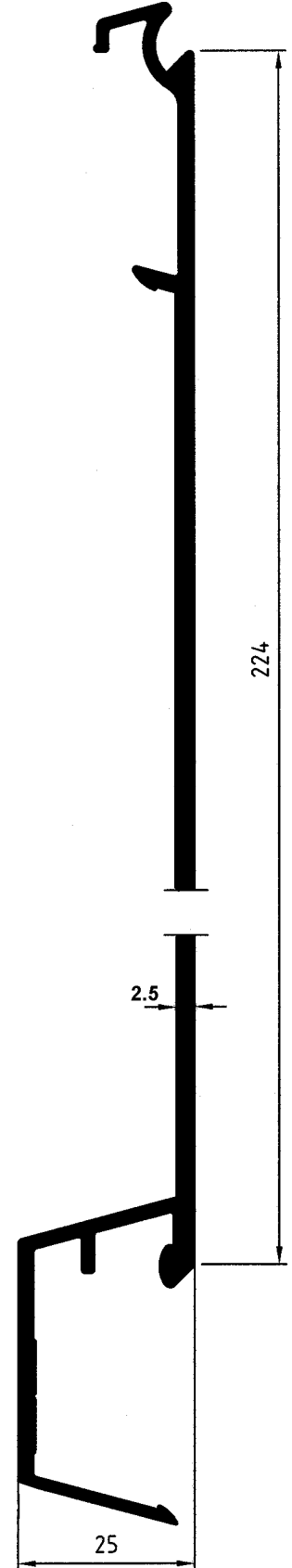

DC 10015
2,70 kg/m
Code
1101335 6,425 m

**Gesloten opbouw
Fourgon
Kastenwagen**

D-3-9

25 mm

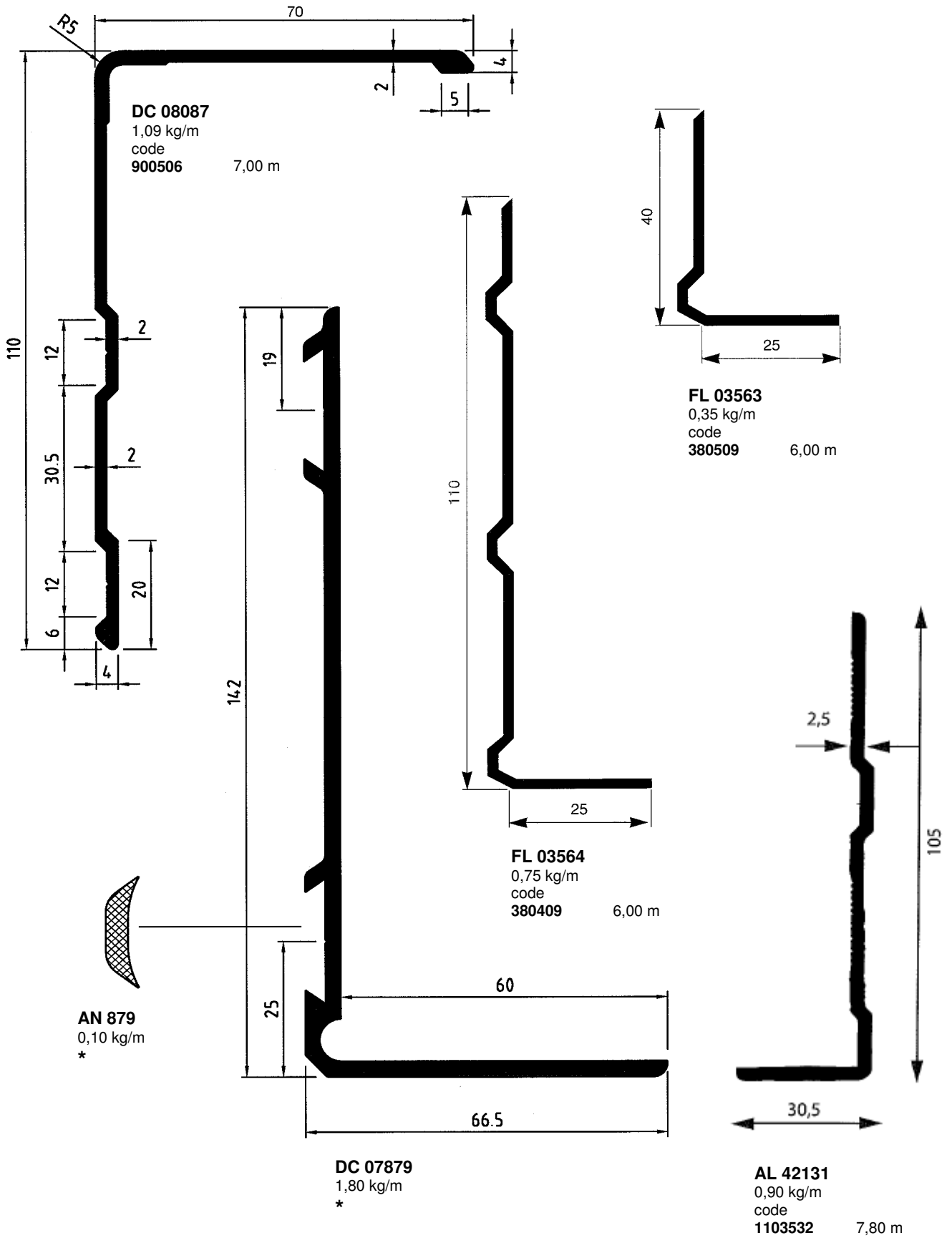

“Integraal-2004” achterdeuren
Porte “Intégrale-2004” sans saillie 25 mm
“Integral-2004” Heck-Türen

D-3-10

schrauwenrs

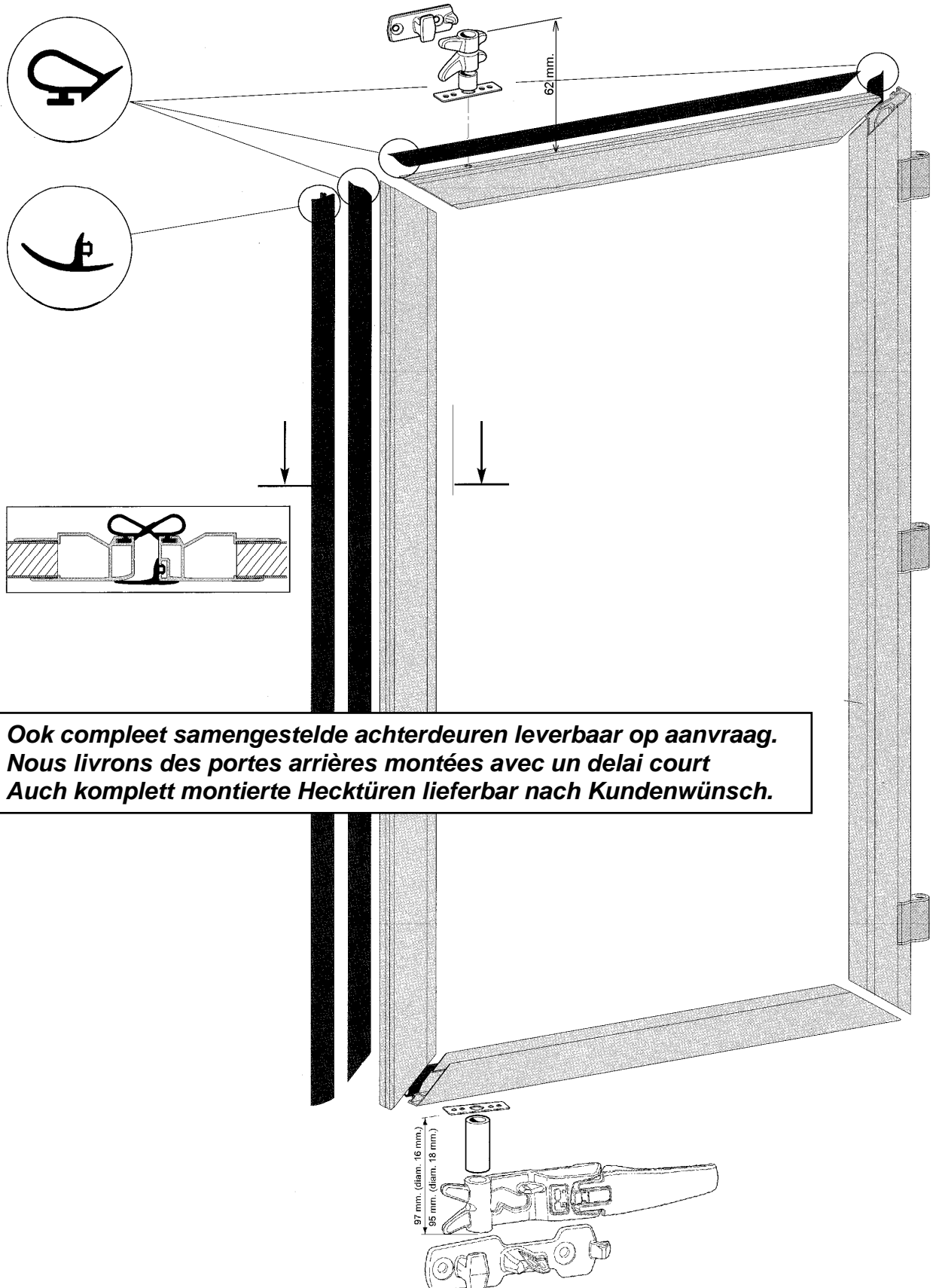









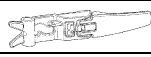

Ook compleet samengestelde achterdeuren leverbaar op aanvraag.
Nous livrons des portes arrières montées avec un délai court
Auch komplett montierte Hecktüren lieferbar nach Kundenwunsch.

“Integraal-2004” achterdeuren
Porte “Intégrale-2004” sans saillie 25 mm
“Integral-2004” Heck-Türen

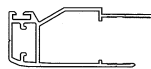
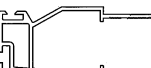
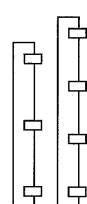
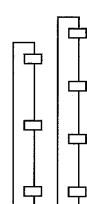
D-3-11

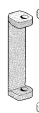
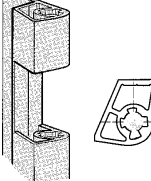
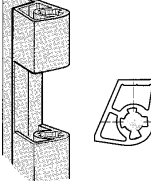
Leverbaar in kit-vorm - Kits porte sans saillie - Kit für Hecktüren

Blz. Page Seite	Symbol Symbole Symbol	Beschrijving	Description	Bezeichnung	Nr. Code
D-3-10		Onderbouwsluiting Ø 16 mm	Crémone Ø 16 mm	Unterbau-drehstangverschluss Ø 16 mm	647216*
		As Ø 16 mm, staal- verz. L=6000 mm	Axe Ø 16 mm, L=6000 mm acier galvanisé.	Achse Ø 16 mm, L=6000 mm Stahl verzinkt.	647126*
		Onderbouwsluiting Ø 18 mm	Crémone Ø 18 mm	Unterbau-drehstangverschluss Ø 18 mm	647217
		As Ø 18 mm, staal- verz. L=6000 mm	Axe Ø 18 mm, L=6000 mm acier galvanisé.	Achse Ø 18 mm, L=6000 mm Stahl verzinkt.	647128*
D-3-12		Rubberprofiel E.P.D.M. zwart 18 m	Joint d'étanchéité, E.P.D.M. noir 18 m	Gummiprofiel E.P.D.M. schwarz 18 m	647202
		Rubberprofiel midden E.P.D.M. zwart 3,2 m	Joint frontal, E.P.D.M. noir 3,2 m	Gummiprofiel mitte E.P.D.M. schwarz 3,2 m	647103
		Alu profiel boven- onder 2,5 m	Profil Alu d'encadrement 2,5 m	Profil Alu oben-unten 2,5 m	647204
		Profiel midden-links 2,8 m 3,2 m	Profil Alu central-gauche 2,8 m 3,2 m	Profil Alu mitte vertikal - Links 2,8 m 3,2 m	647208 647205
		Profiel midden-rechts 2,8 m 3,2 m	Profil Alu central-droit 2,8 m 3,2 m	Profil Alu mitte vertikal - Rechts 2,8 m 3,2 m	647209 647206
		Alu scharnierprofiel 3 scharnieren 2,6 m	Profil charnière 3 charnières 2,6 m	Scharnier-profiel 3 Scharnieren 2,6 m	647210
		Alu scharnierprofiel 4 scharnieren 3,2 m	Profil charnière 4 charnières 3,2 m	Scharnier-profiel 4 Scharnieren 3,2 m	647201
		Kunststof hoekstuk (8)	Ensemble rigidificateur d'angle (8)	Kunststoff EckStück (8)	647212
		Scharnierbok - staal	Chape acier	Scharnier-bock Stahl	647211
		Scharnier-hulpprofiel 2,6 m	Profil support charnière 2,6 m	Alu Scharnier-montageprofiel 2,6 m	647213
		Scharnier-hulpprofiel 3,2 m	Profil support charnière 3,2 m	Alu Scharnier-montageprofiel 3,2 m	647214
		As Ø 10 mm, staal- verz. L=2365 mm	Axe Ø 10 mm, L=2365 mm acier galvanisé.	Achse Ø 10 mm, L=2365 mm Stahl verzinkt.	647215
		Spanhuls	Goupille elastique inox	Spannstifte	642014

* op aanvraag / sur demande / auf Anfrage

“Integraal-2004” achterdeuren
Porte “Intégrale-2004” sans saillie 25 mm
“Integral-2004” Heck-Türen

D-3-12

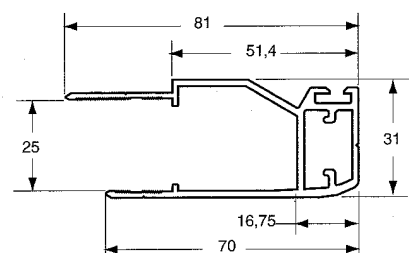
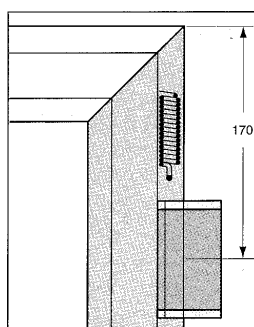
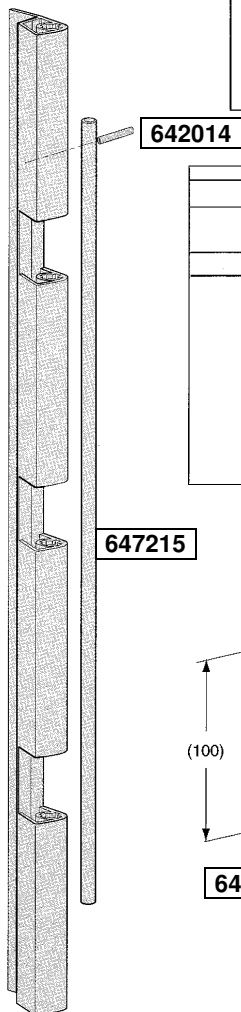
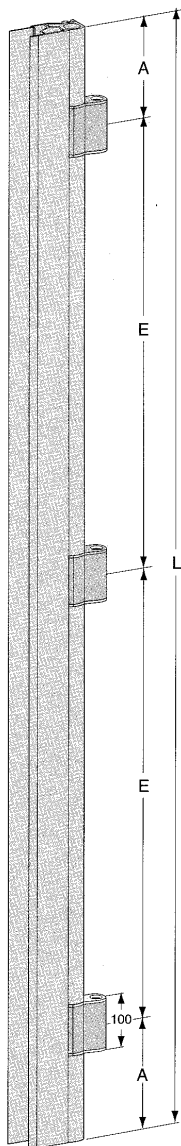
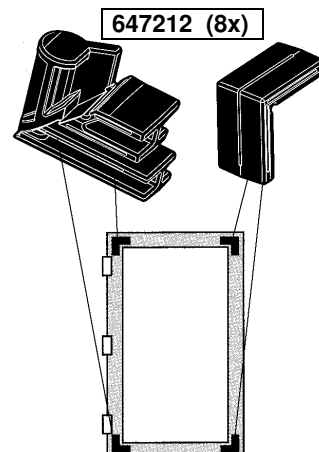
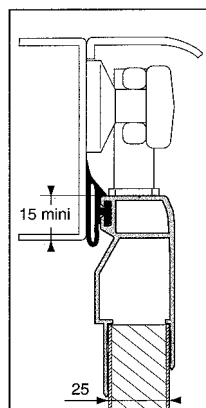
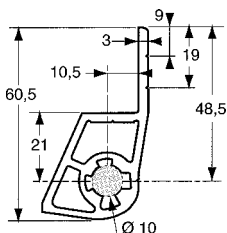
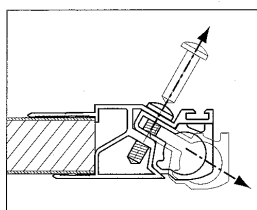

647204	2500 mm.
647208	2800 mm.
647205	3200 mm.

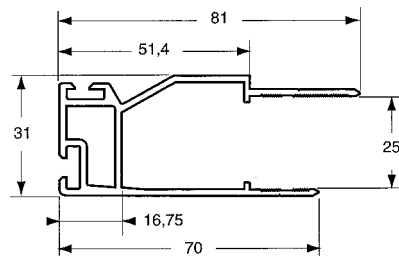
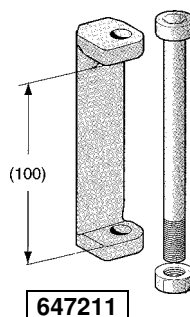

647209	2800 mm.
647206	3200 mm.

647213	2600 (3)
647214	3200 (4)



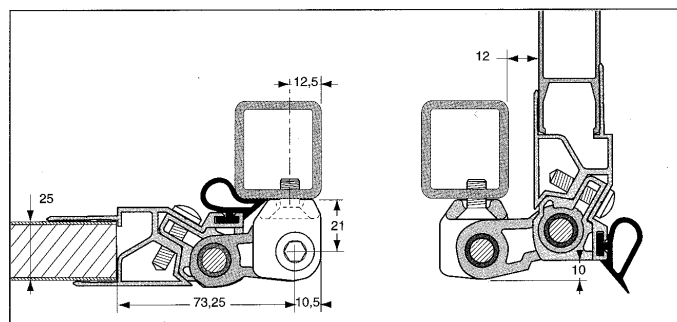
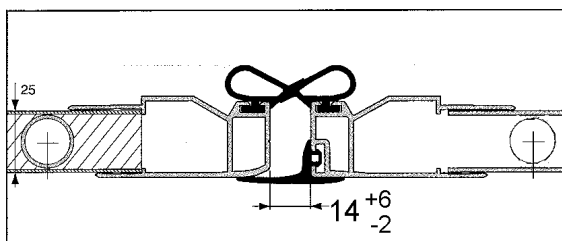
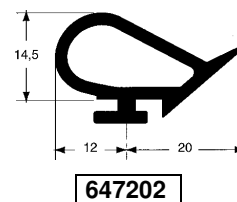
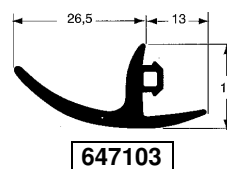













	647210 (3)	647201 (4)
L (mm.)	2600	3200
E (mm.)	840	745
A (mm.)	460	482.5
G (kg/st-p.)	5,9	7,3

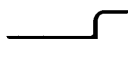

**Gesloten opbouw
Fourgon
Kastenwagen**

30 mm

D-4-1

Blz. Page Seite	Profiel nr. Nr. de profil Profil Nr.	Gewicht Poids Gewicht	Symbool Symbole Symbol	Beschrijving Description Bezeichnung	Lengte Longueur Länge
D-4-2	AN 830	2,98 kg/m		Scharnier compleet Charnière complète Scharnier Komplett	2,40 m 3,00 m
	FL 00156	0,85 kg/m		Deurprofiel Profilé de porte Türrahmenprofil	6,00 m
	AN 575	0,56 kg/m		Rubberprofiel Joint Dichtgummi	6,50 m
	FL 08062	1,08 kg/m		Deurprofiel Profilé de porte Türrahmenprofil	6,50 m
	FL 00154	0,76 kg/m			6,00 m
D-4-3	FL 22150	2,15 kg/m		Bovenrandprofiel Profilé supérieur Oberes Randprofil	7,50 m 13,50 m
	AG 3654-08	0,31 kg/st-p		Kapbol (lasbaar) Calotte (à souder) Eckkalotte (Schweisssbar)	
	AG 5480-06	0,27 kg/st-p		Kapbol (verlijmen) Calotte (à coller) Eckkalotte (Verkleben)	
	AN 899	0,15 kg/m		Rubberprofiel Joint Dichtgummi	50 m
	AN 625	0,15 kg/m			50 m
	AN 502	0,20 kg/m			50 m
	DC 07847	1,00 kg/m		Deurprofiel Profilé de porte Türrahmenprofil	6,50 m
	DC 07846	0,94 kg/m			6,50 m
D-4-4	FL 08962	2,46 kg/m		Bovenrandprofiel Rive Gurtprofiel	7,50 m
	FL 07441	1,78 kg/m			*
	DC 08087	1,09 kg/m			7,00 m
	FL 03564	0,75 kg/m			6,00 m

**Gesloten opbouw
Fourgon
Kastenwagen**

30 mm

D-4-2

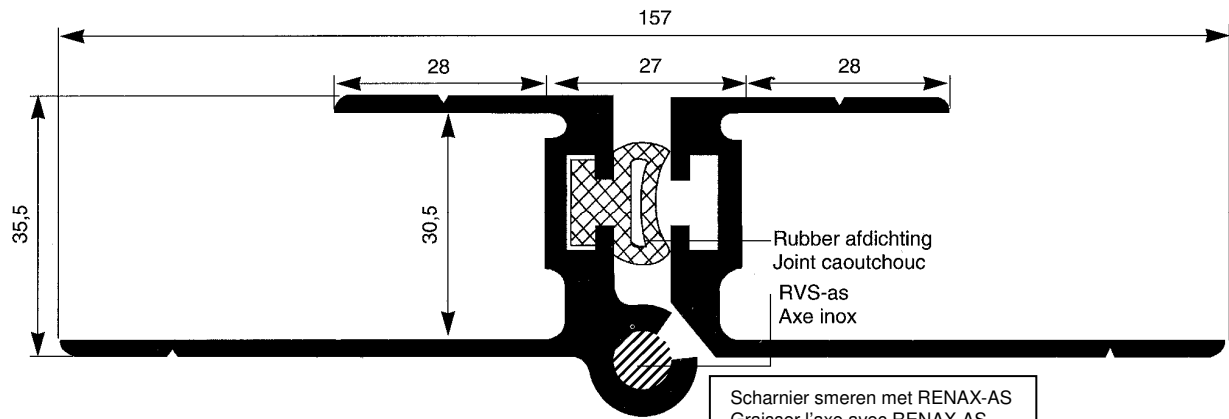

Scharnier smeren met RENAX-AS
Graisser l'axe avec RENAX-AS
Scharnier smieren mit RENAX-AS

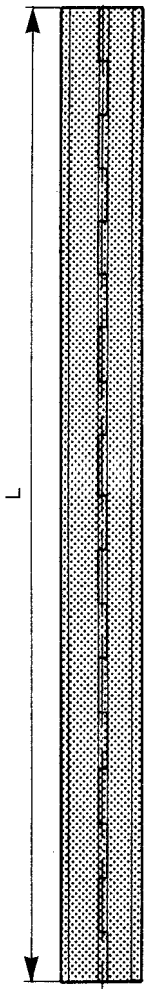

AN 830
2,98 kg/m
code
449740 L= 2400 mm
449780 L= 3000 mm

RVS as
Axe inox
Inox Achse
L= 2400 mm
L= 3000 mm

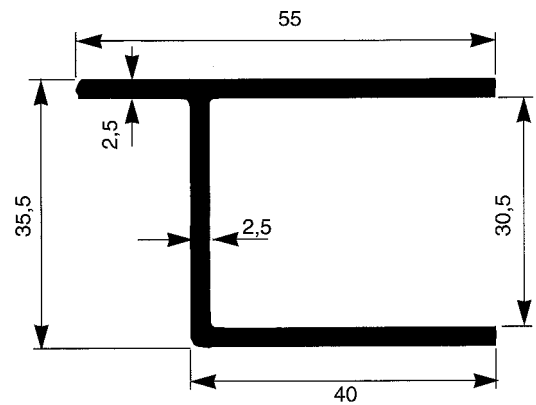

FL 00156
0,85 kg/m
code
370509 6,00 m

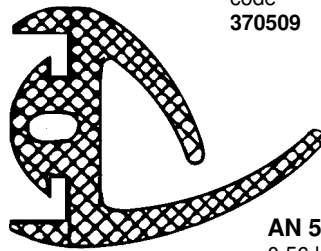

AN 575
0,56 kg/m
code
444055 6,50 m

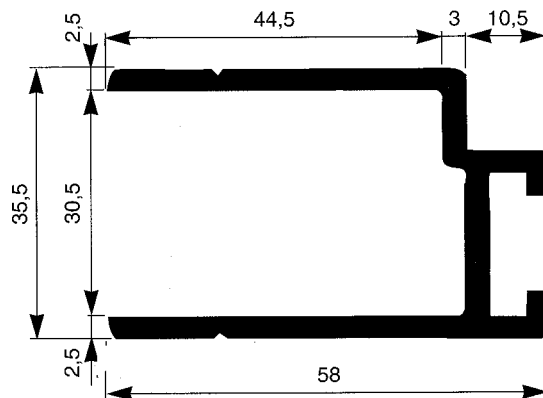

FL 08062
1,08 kg/m
code
383211 6,50 m

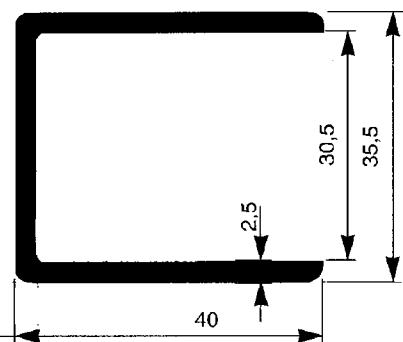

FL 00154
0,76 kg/m
code
370609 6,00 m

**Gesloten opbouw
Fourgon
Kastenwagen**

30 mm

D-4-3

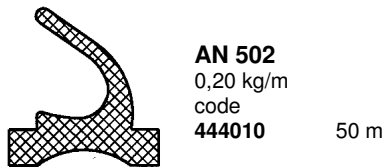
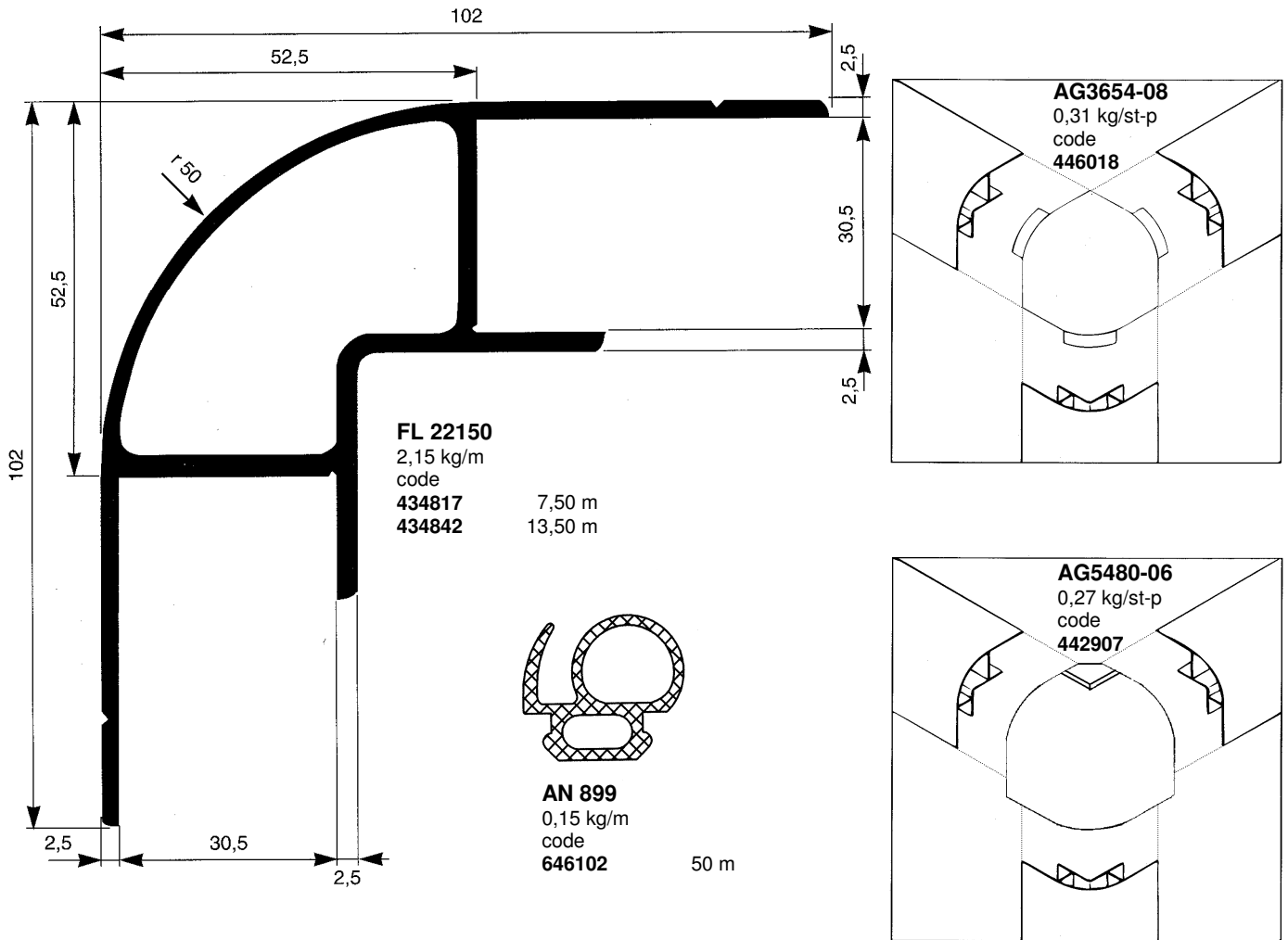

**Of
Ou
Oder**

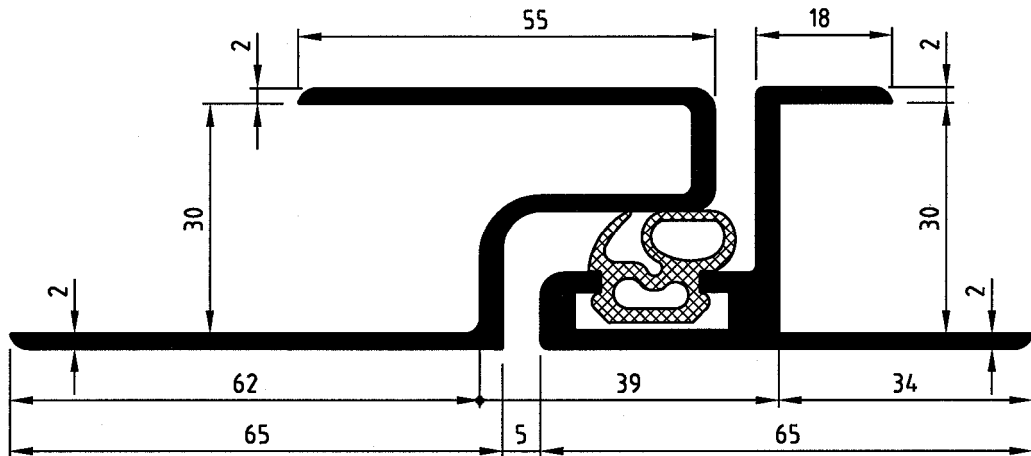

DC 07847
 1,00 kg/m
 code
 386111 6,50 m

DC 07846
 0,94 kg/m
 code
 386011 6,50 m





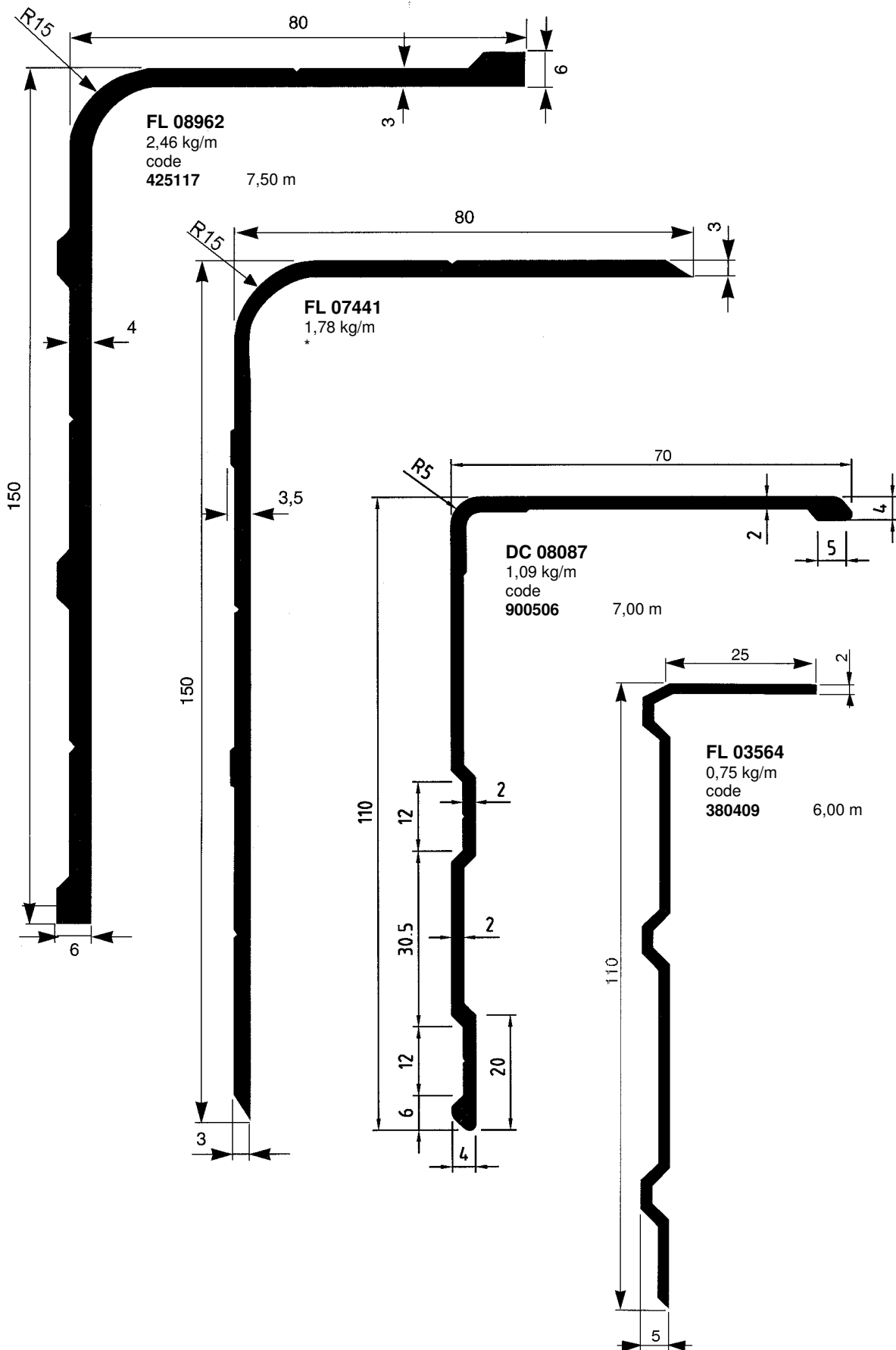

**Gesloten opbouw
Fourgon
Kastenwagen**

D-4-4

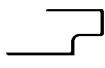

Koelwagen / Paneelkonstruktie
Fourgon frigorifique / Construction Panneaux
Kühlwagen / Panel-Aufbau

D-5-1

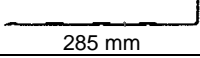
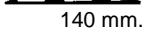
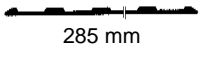
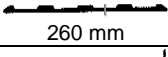
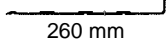
Blz. Page Seite	Profiel nr. Nr. de profil Profil Nr.	Gewicht Poids Gewicht	Symbool Symbole Symbol	Beschrijving Description Bezeichnung	Lengte Longueur Länge
D-5-2	FL 06035	2,68 kg/m		Onderrandprofiel Rive inférieure Untergurtprofil	*
	FL 06441	2,60 kg/m			7,50 m
	FL 05806	1,42 kg/m			7,50 m
D-5-3	FL 06817	1,25 kg/m		Bovenrandprofiel Profilé supérieur Oberes Randprofil	7,50 m
	FL 06818	0,70 kg/m		Binnenrandprofiel Rive sup. Intérieure Eckprofil innen	7,50 m
	DC 07849	1,10 kg/m		Rubberprofiel Joint Dichtgummi	6,50 m
	DC 07848	1,00 kg/m		Deurprofiel Profilé de porte Türrahmenprofil	6,50 m
D-5-4	FL 07478	2,59 kg/m		Stootlijst Lisse de protection Stossleiste	6,75 m
	FL 08762	1,10 kg/m			6,75 m
	FL 05823	2,14 kg/m			6,75 m
	DC 07460	1,60 kg/m			*
	DC 07461	2,00 kg/m			*

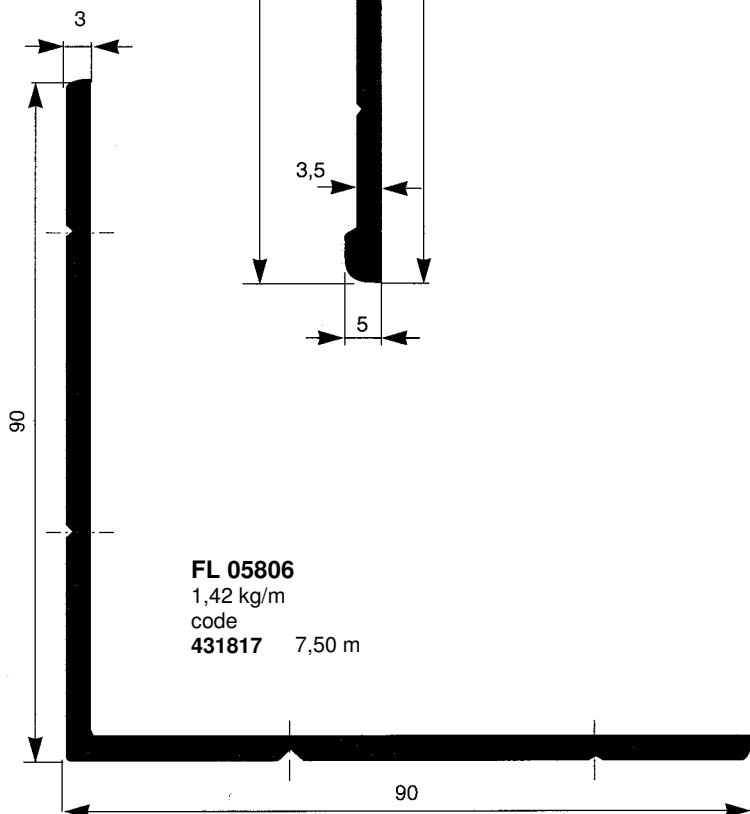
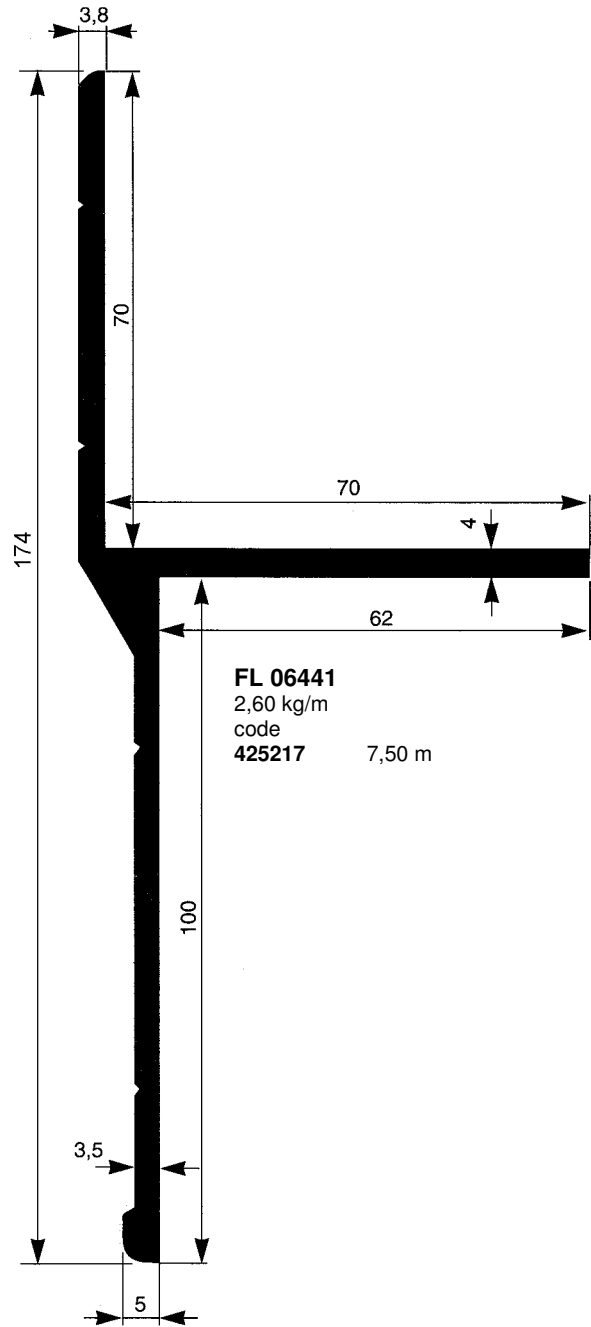
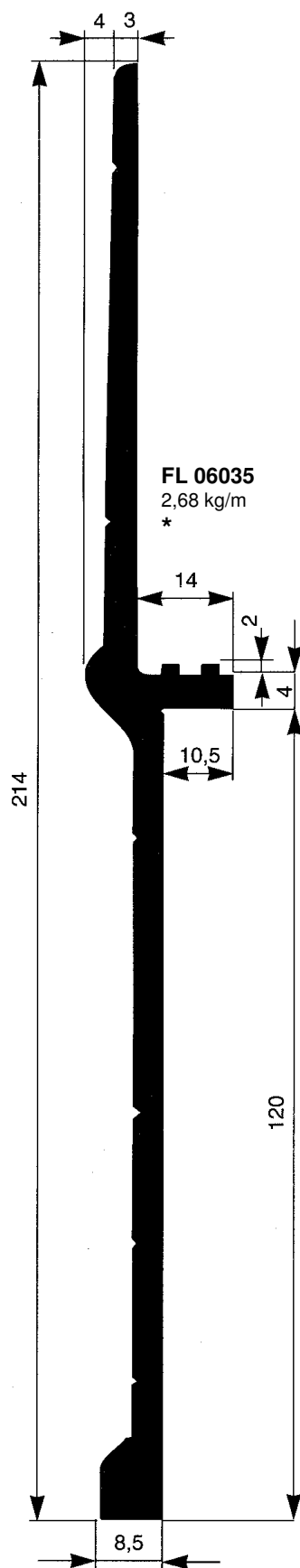

Koelwagen / Paneelkonstruktie
Fourgon frigorifique / Construction Panneaux
Kühlwagen / Panel-Aufbau

D-5-3

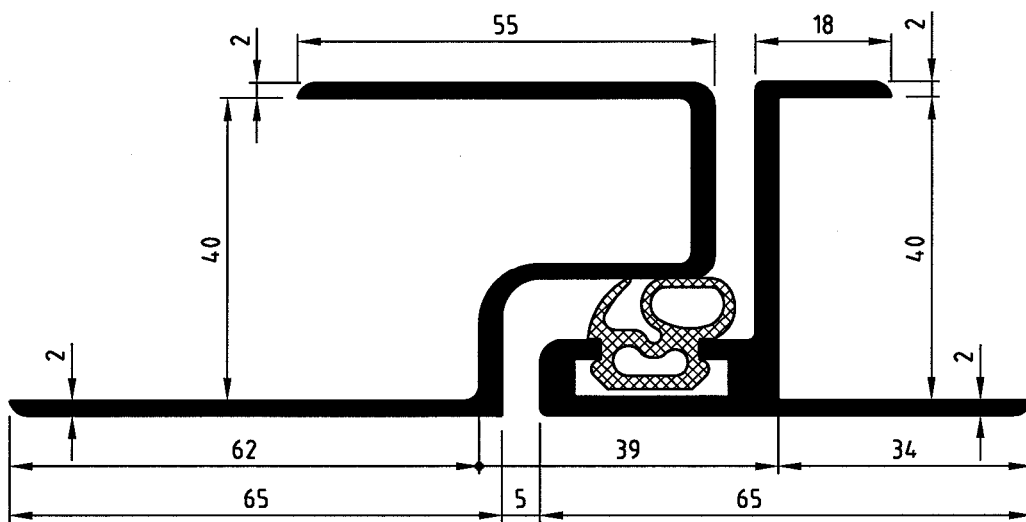
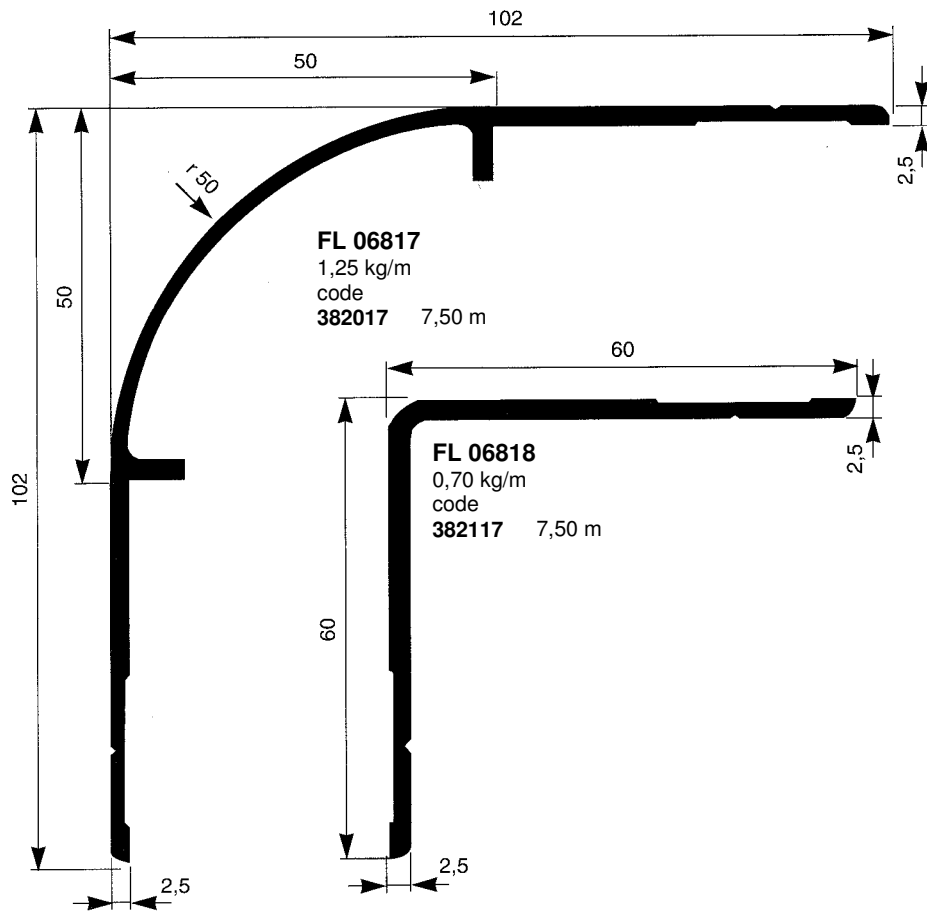

DC 07849
 1,10 kg/m
 code
 426111 6,50 m

DC 07848
 1,00 kg/m
 code
 426011 6,50 m

Koelwagen / Paneelkonstruktie
Fourgon frigorifique / Construction Panneaux
Kühlwagen / Panel-Aufbau

D-5-4

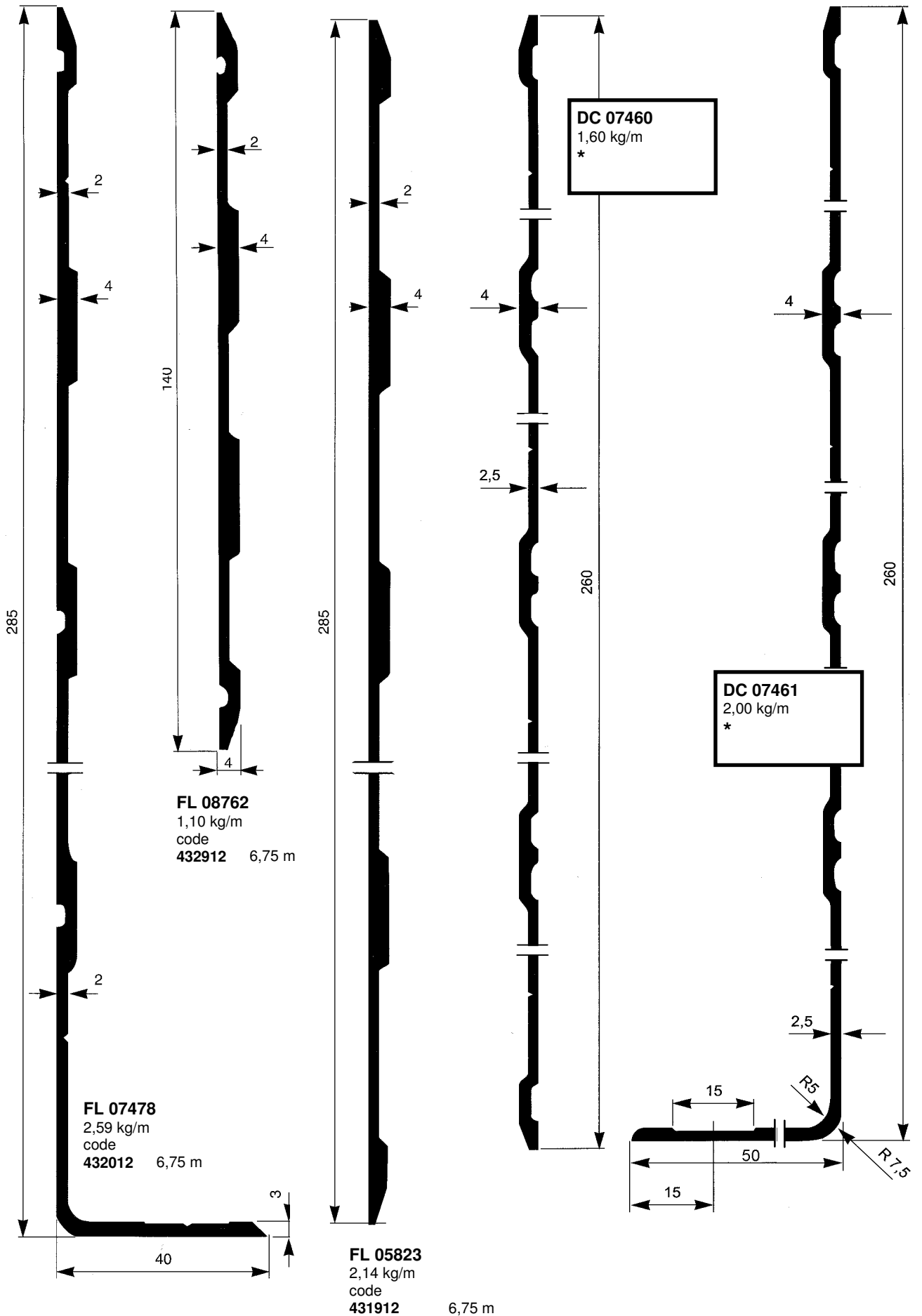

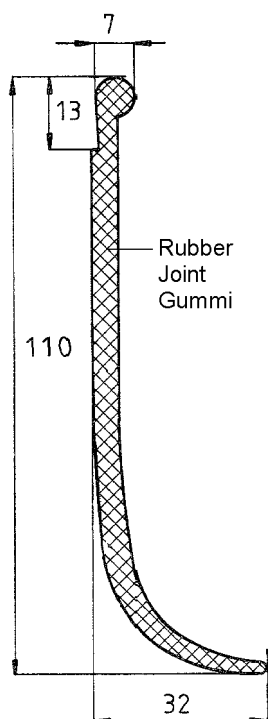

AN 621
 0,87 kg/m
 Code
642303 28,00 m

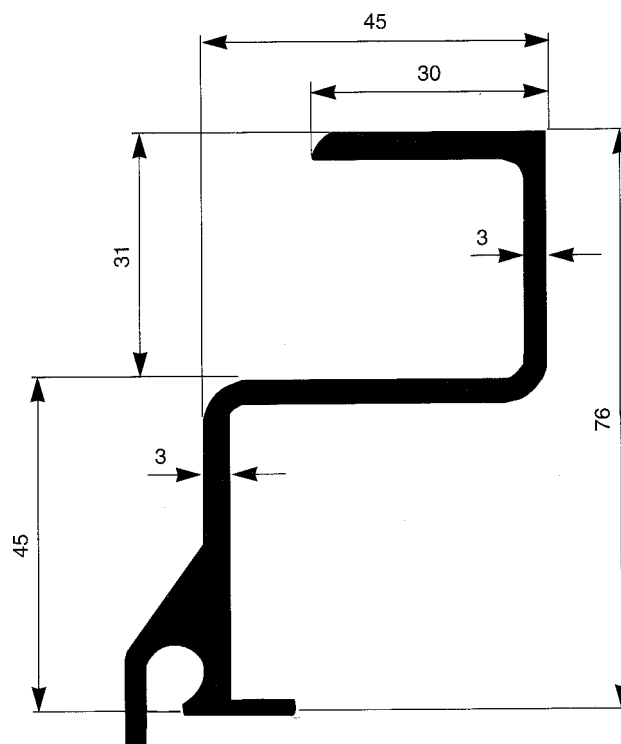

FL 08946
 1,40 kg/m
 Code
425745 13,70 m

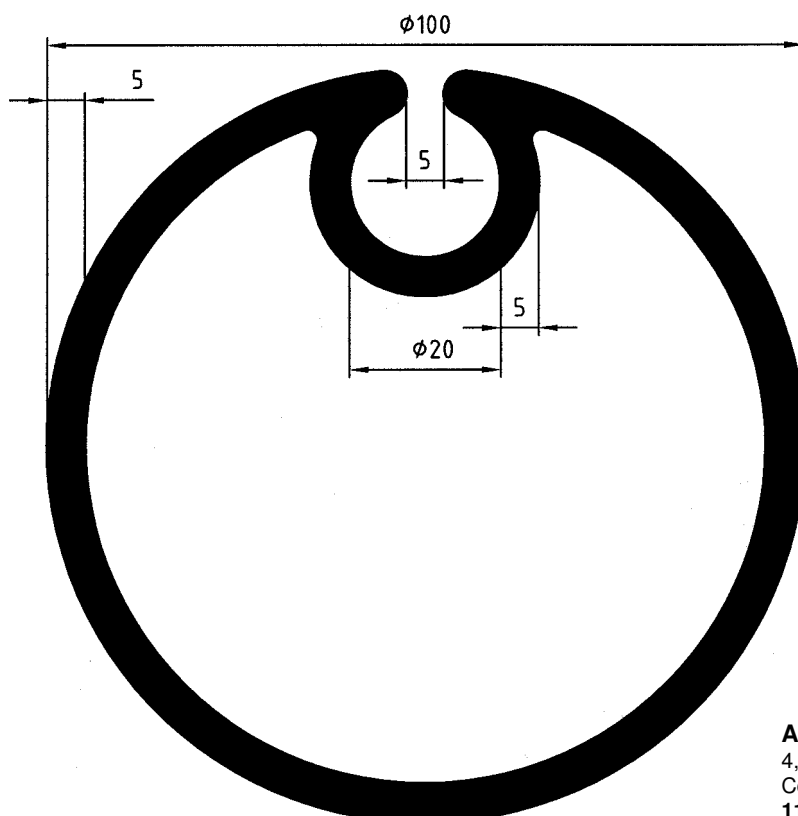

AL 16783
 4,95 kg/m
 Code
1100202 13,60 m