

Laadbak / vloeren
Plateau / plancher
Pritsche / Boden

30 mm
40 mm

B-1-1

Groot formaat rijstekorrelplaat
Tôles "grand format" – grain d'orge
Groß Format Reiskornblech

AlMg4Mn (5086 H244)

Achterzijde – Face arrière - Rückseite : Primer 08F / 15 µm

code	Dikte Epaisseur Dicke	Afmetingen Dimensions Abmessungen	kg/m ²	kg/st-p
179826	2.7	8000 x 2480	7,36	147,15









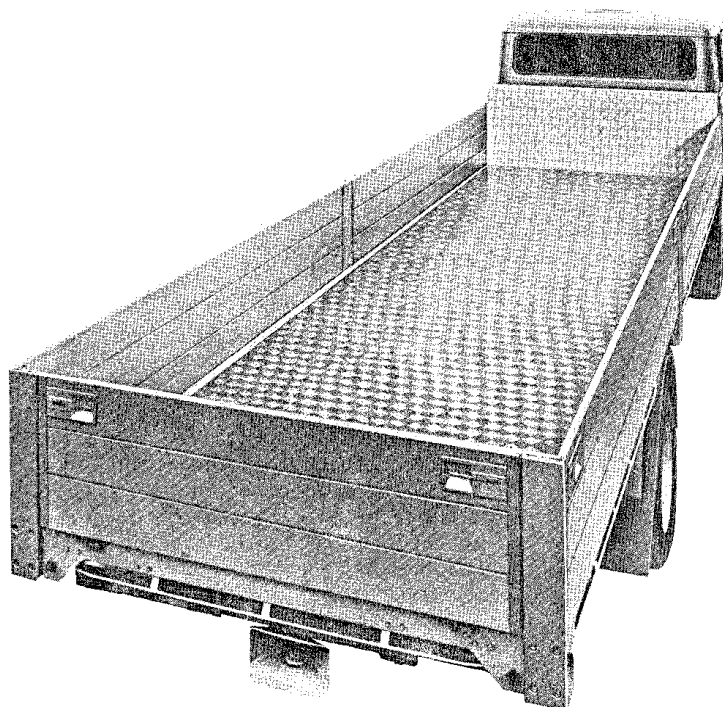

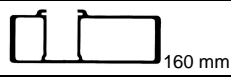
Groot formaat tranenplaat
Tôles damier grand format
Groß Format Warzenblech

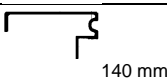
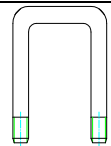
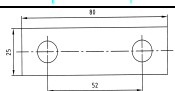
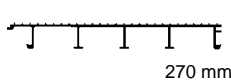
Groot formaat tranenplaat, niet gebeitst, 5-tranen, niet zetbaar
Tôles damier grand format non décapées, 5 stries,
Groß Format Warzenblech, nicht gebeitzt, 5 Träne, nicht verformbar
Anticorodal-100® (AlMgSi1, min. F31)

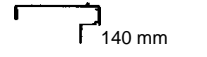
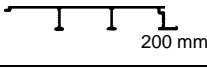
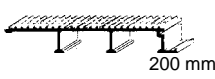
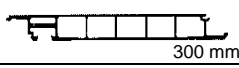
code	Dikte Epaisseur Dicke	Afmetingen Dimensions Abmessungen	kg/m ²	kg/st-p
178835	3,5 / 5	8000 x 2500	10,6	212
178855	5 / 7	8000 x 2500	15,24	304,7

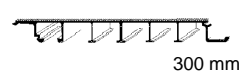

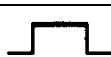
Blz. Page Seite	Profiel nr. Nr. de profil Profil Nr.	Gewicht Poids Gewicht	Symbol Symbole Symbol	Beschrijving Description Bezeichnung	Lengte Longueur Länge
B-1-3	AL 30497	2,72 kg/m		Randprofiel Profilé de rive	7,20 m
	DC 08834	4,60 kg/m		Seitenrandprofiel	5,10 m 8,00 m
	CH 53720	3,56 kg/m		Dwars- of langsligger Traverse ou longeron	7,50 m
	DC 08940	3,92 kg/m		Quer- oder Langträger	5,00 m 7,50m
B-1-4	FL 12917	3,13 kg/m		Randprofiel Profilé de rive Seitenrandprofiel	7,30 m
		0,12 kg/st-p		Haak vastzetten lading Anneau d'arrimage Ladesicherung	
		0,12 kg/st-p		Montage strip Barette acier Montage-Platte	
	AL 12356	3,55 kg/m (13,15 kg/m ²)		Vloerprofiel anti-slip Profilé de plancher cannelé dentelé Bodenplanke rutschfest	7,35 m
B-1-5	FL 08376	3,48 kg/m		Randprofiel Profilé de rive	13,70 m
	CH 52362	3,02 kg/m		Seitenrandprofiel	7,30 m
B-1-6	CH 41960	2,52 kg/m (12,60 kg/m ²)		Vloerprofiel glad Profilé de plancher lisse Bodenplanke glatt	6,60 m 7,35 m
	CH 41095	2,85 kg/m (14,25 kg/m ²)		Vloerprofiel geribd Profilé de plancher cannelé dentelé Bodenplanke geriffelt	6,60 m 7,35 m
B-1-7	FL 29007	6,33 kg/m (21,1 kg/m ²)		Vloerprofiel anti-slip Profilé de plancher cannelé dentelé Bodenplanke rutschfest	7,50 m
	DC 08706	4,83 kg/m			6,70 m
	AS 41336 / FL 12787	4,72 kg/m (15,73 kg/m ²)			7,50 m
B-1-8	FL 06665	0,94 kg/m		Vloerprofiel geribd Profilé de plancher cannelé dentelé	7,80 m
	FL 08141	1,30 kg/m		Bodenprofil geriffelt	13,50 m

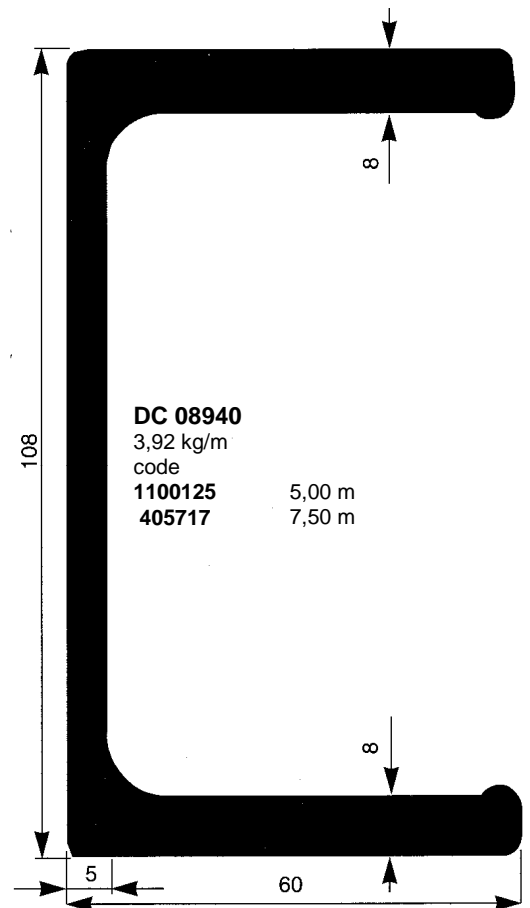
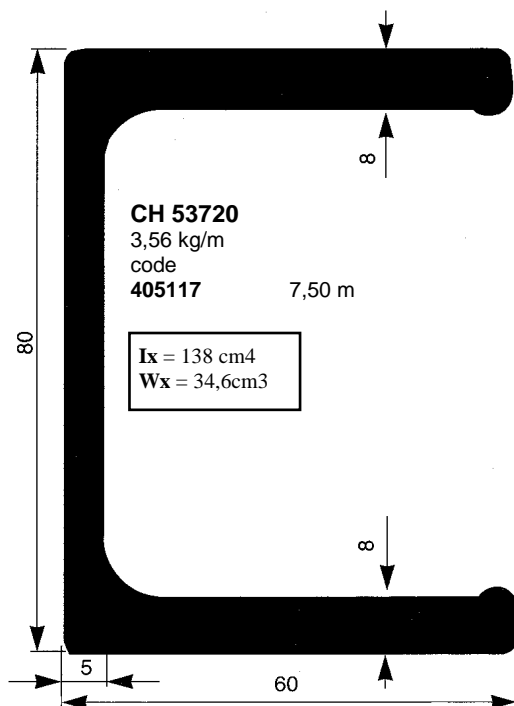
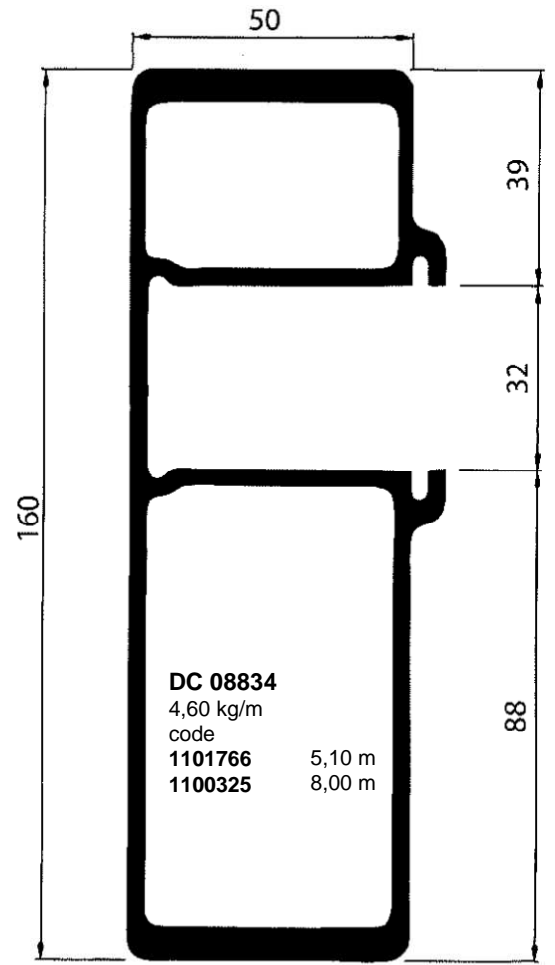
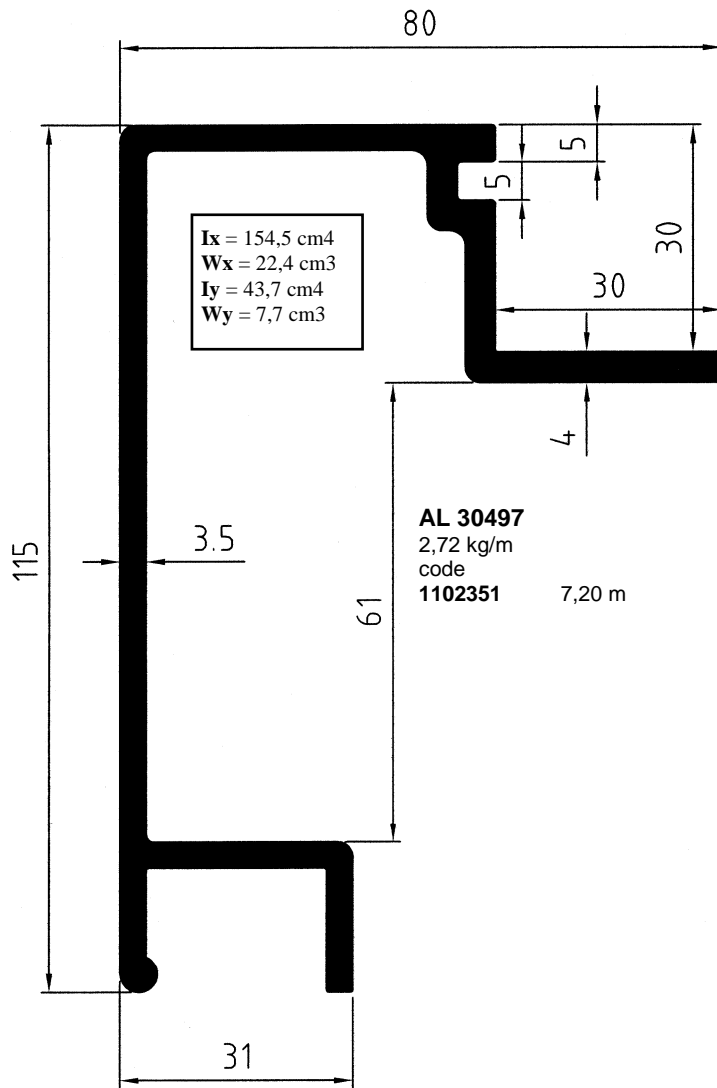

Laadbak / vloeren
 Plateau / plancher
 Pritsche / Boden

B-1-4

30 mm

Haak vastzetten lading
 Anneau d'arrimage
 Ladesicherung

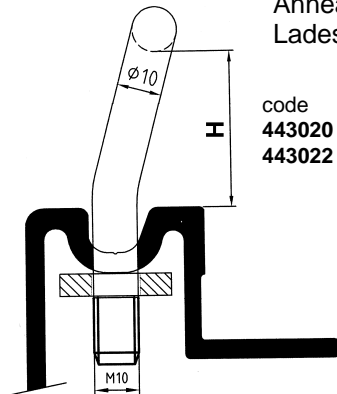

code
443020 H = 35 mm 0,12 kg/st-pc
443022 H = 75 mm 0,18 kg/st-pc

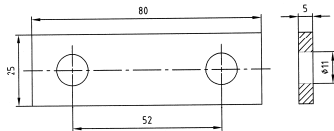

Montage strip
 Barette acier 80*25*5 mm
 Montage-Platte
 code
443021 0,12 kg/st-pc

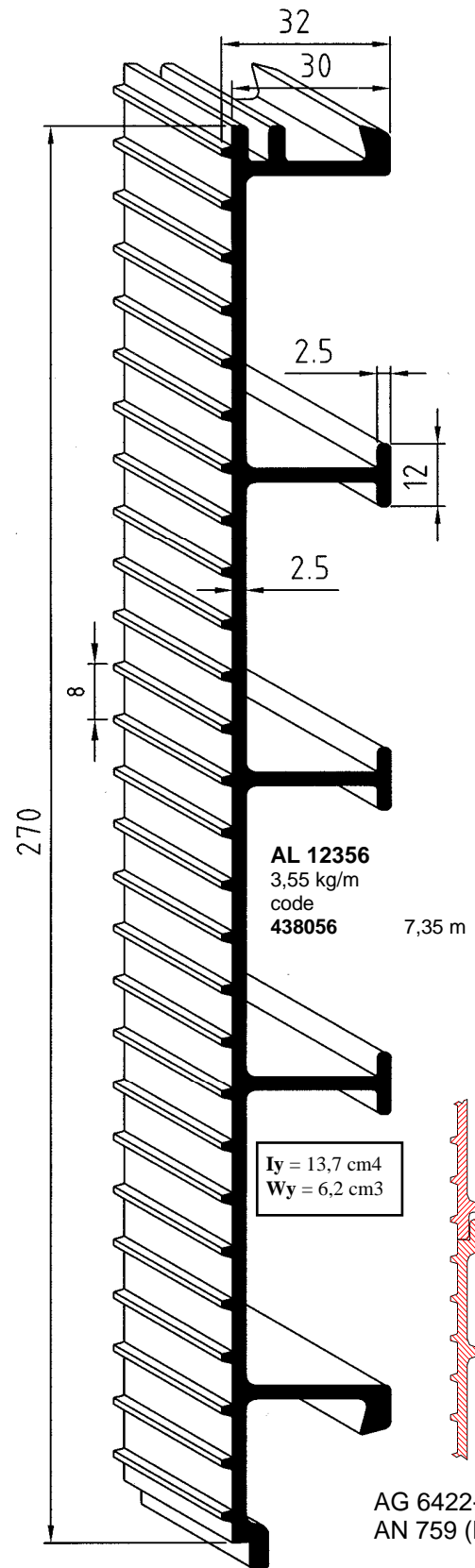
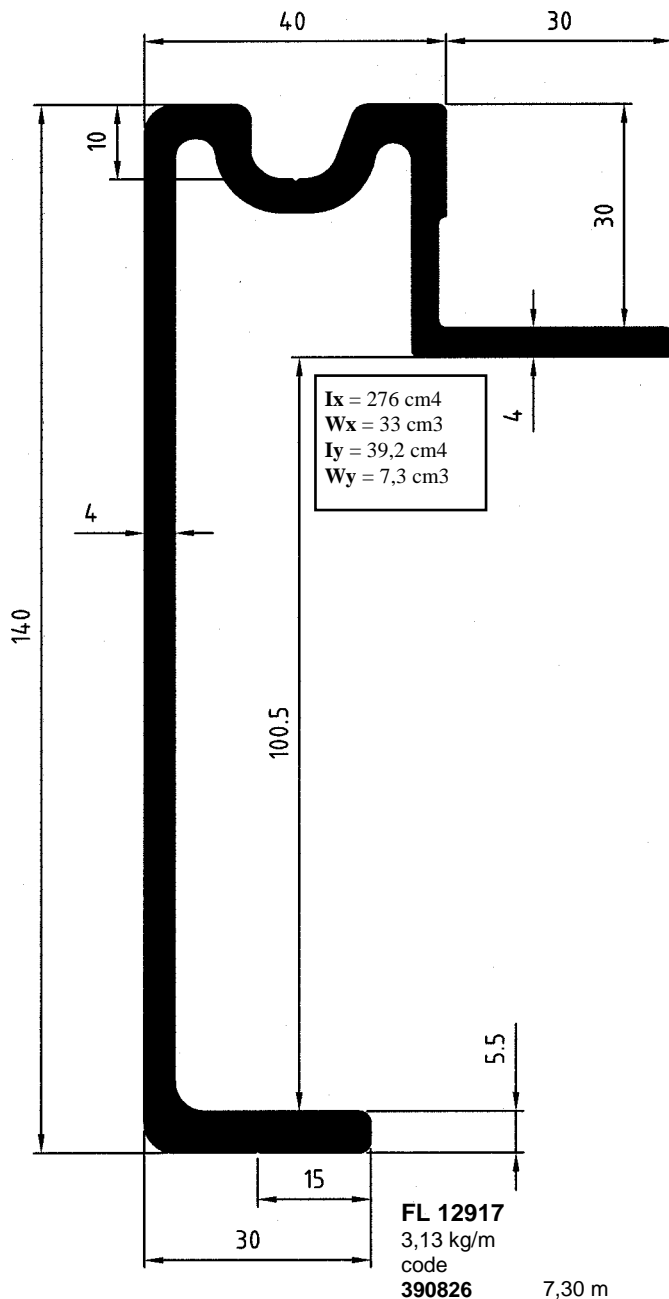

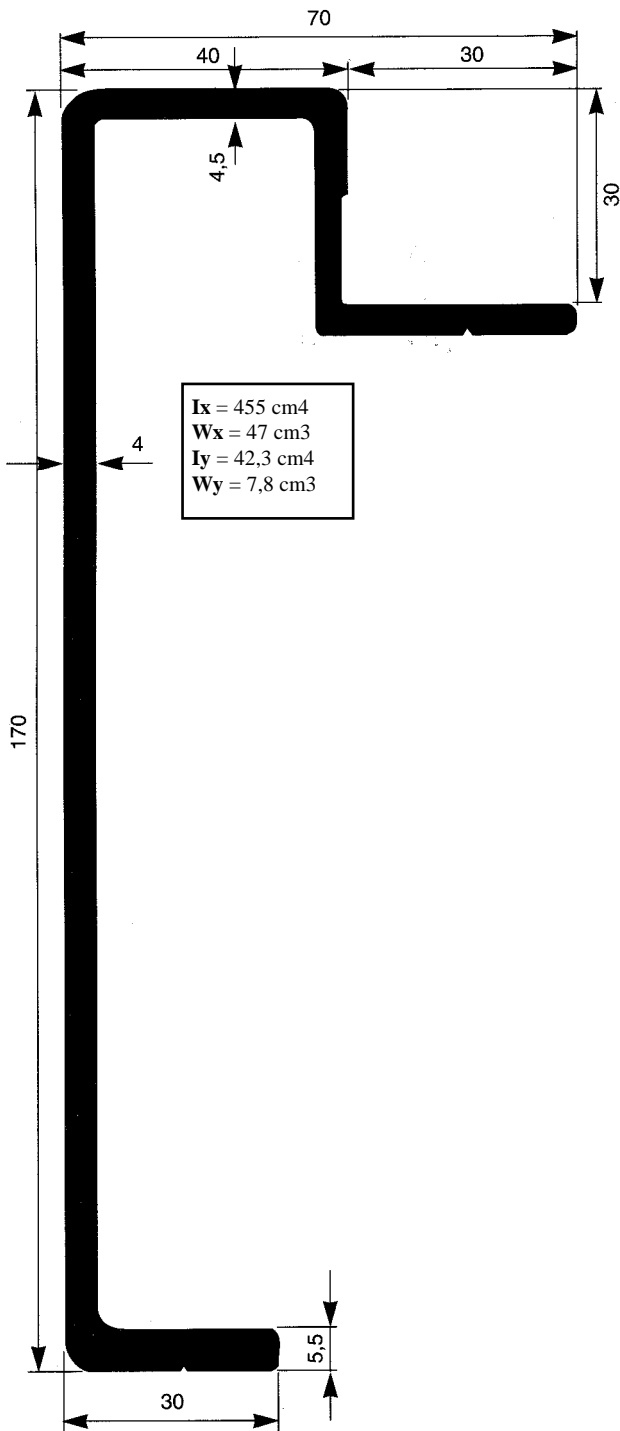

FL 08376
 3,48 kg/m

*

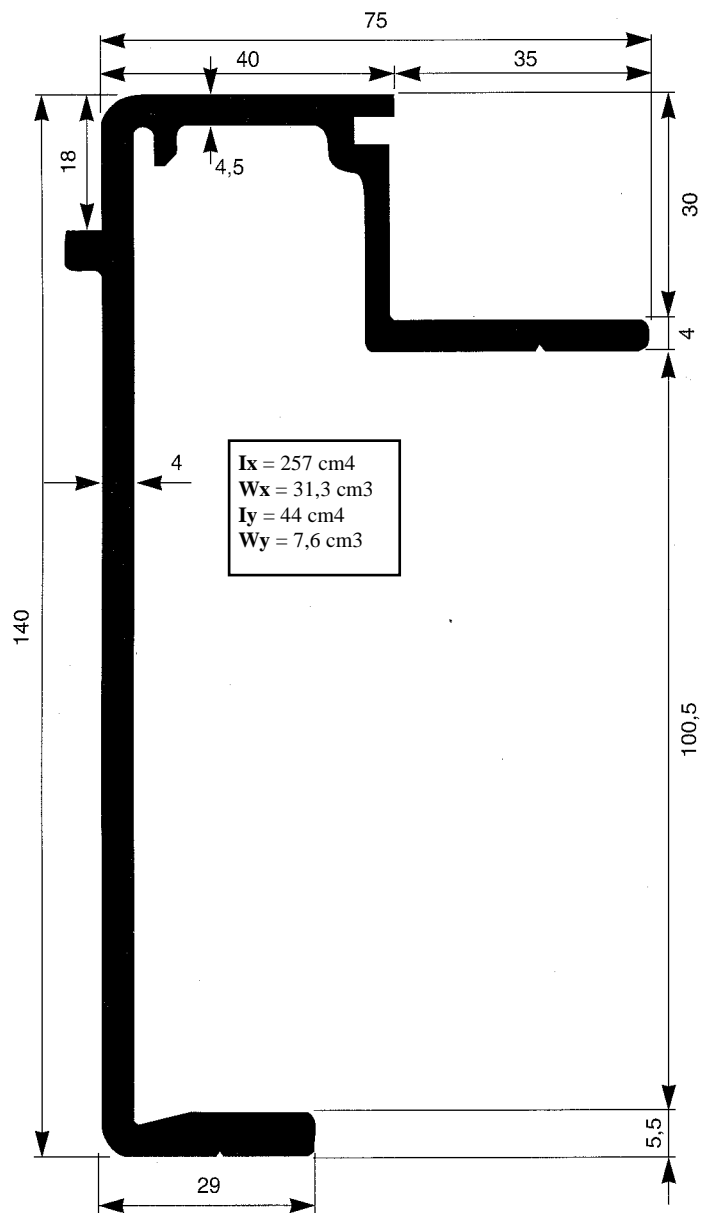

CH 52362
 3,02 kg/m
 code
390416 7,30 m

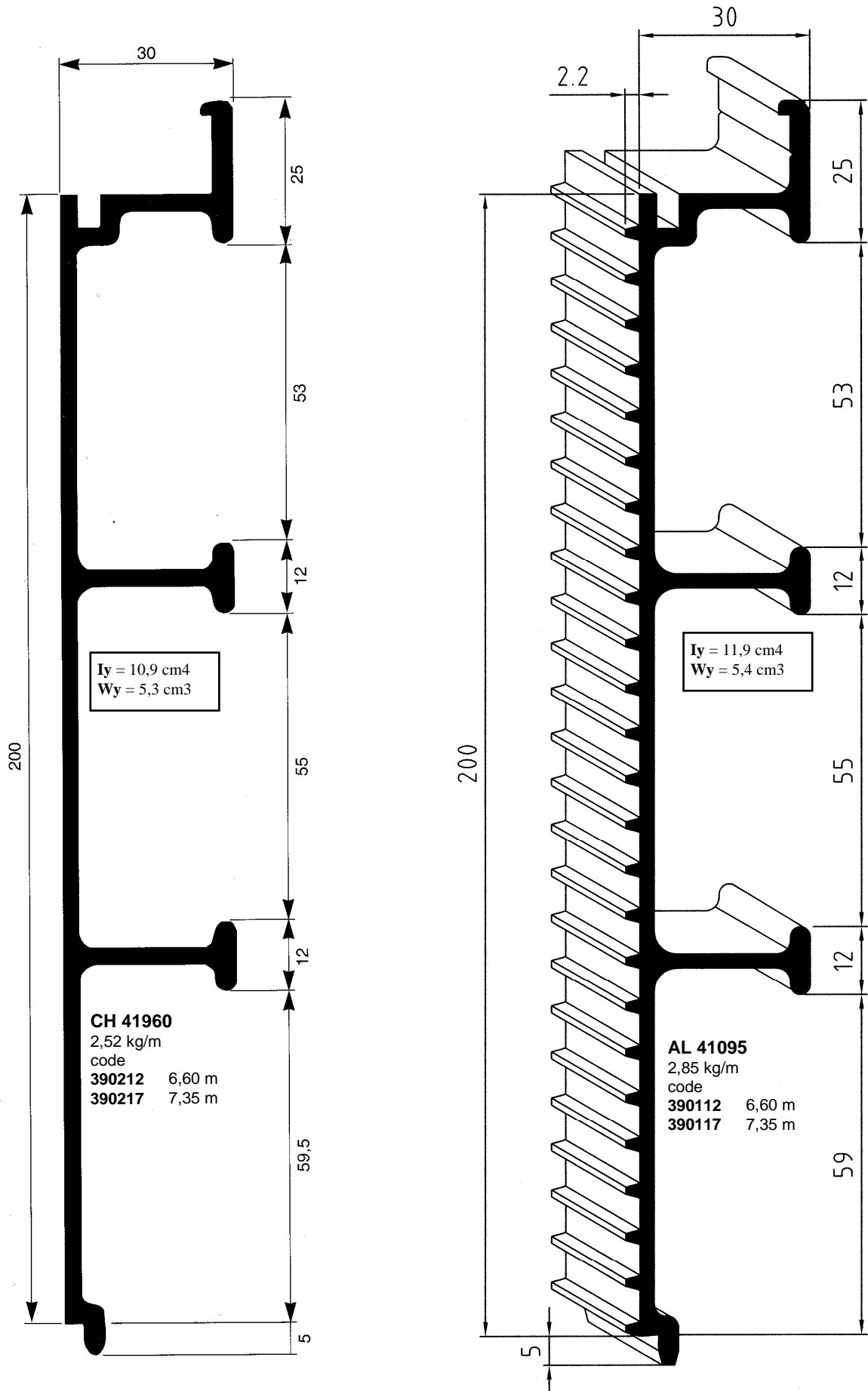

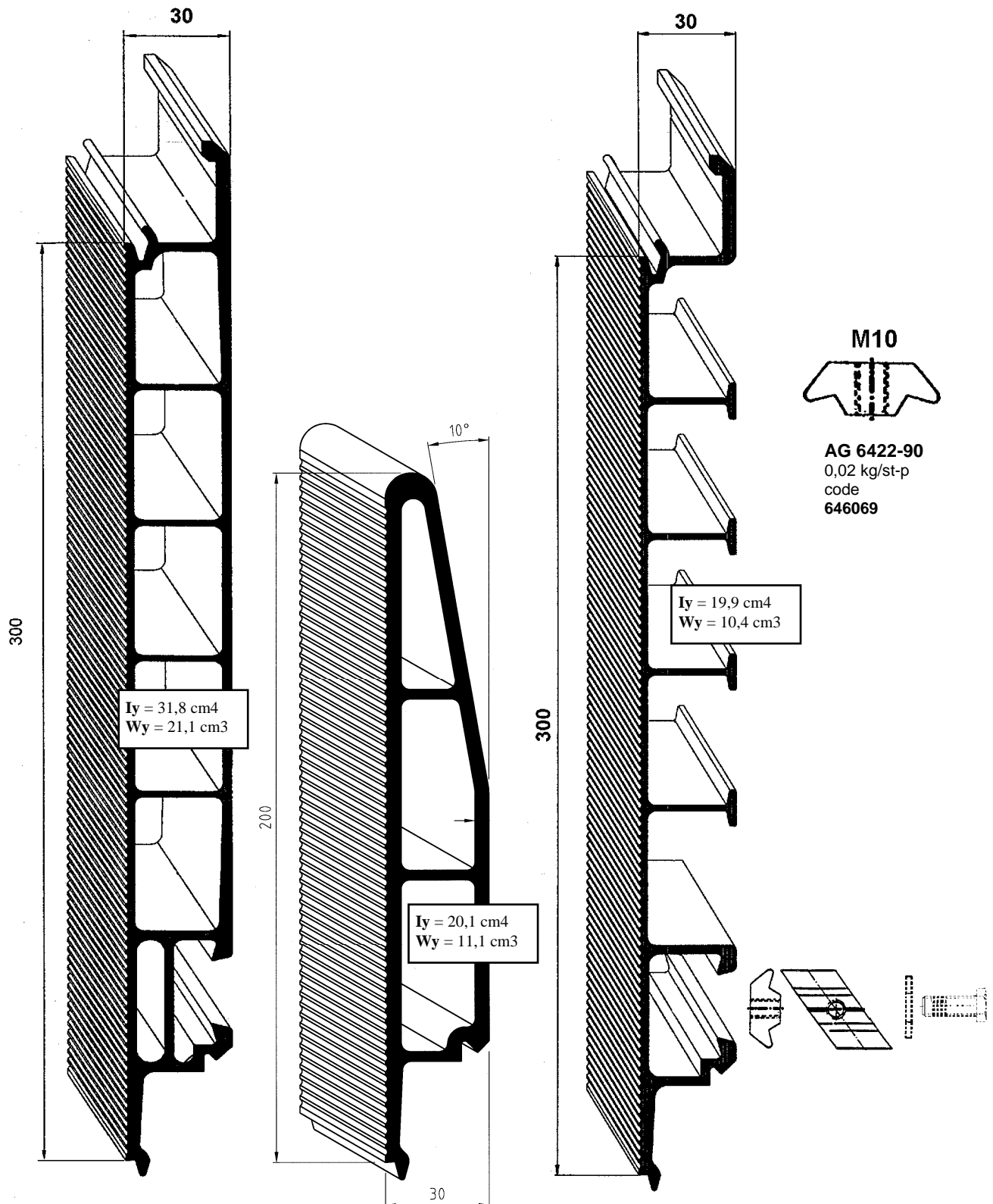

300

30

$I_y = 31,8 \text{ cm}^4$
 $W_y = 21,1 \text{ cm}^3$

200

10°

$I_y = 20,1 \text{ cm}^4$
 $W_y = 11,1 \text{ cm}^3$

30

$I_y = 19,9 \text{ cm}^4$
 $W_y = 10,4 \text{ cm}^3$

300

M10



AG 6422-90
 0,02 kg/st-p
 code
 646069

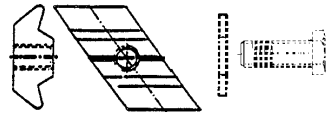

AS40864 / FL 29007
 6,33 kg/m
 code
394017 7,50 m

DC 08706
 4,83 kg/m
 code
903016 6,70 m

AS 41336 / FL 12787
 4,72 kg/m
 code
394217 7,50 m

Geluidsarme aluminium vloeren
 Plancher en aluminium bruit limité
 Geräuscharmen Aluminium Boden



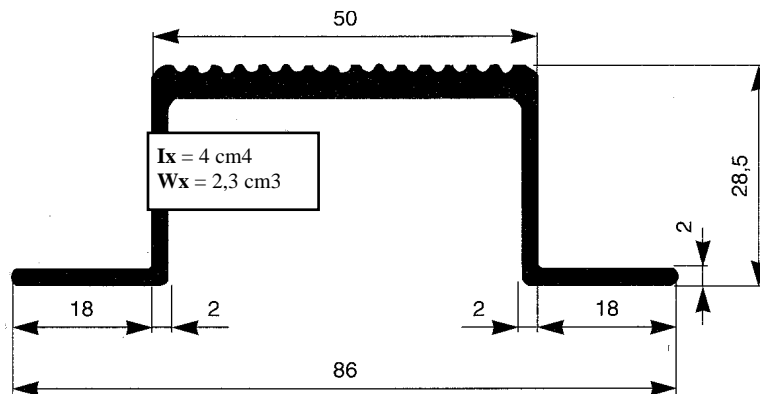
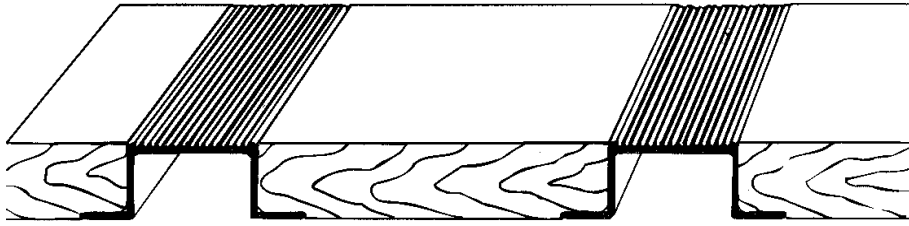

68 dB(A)

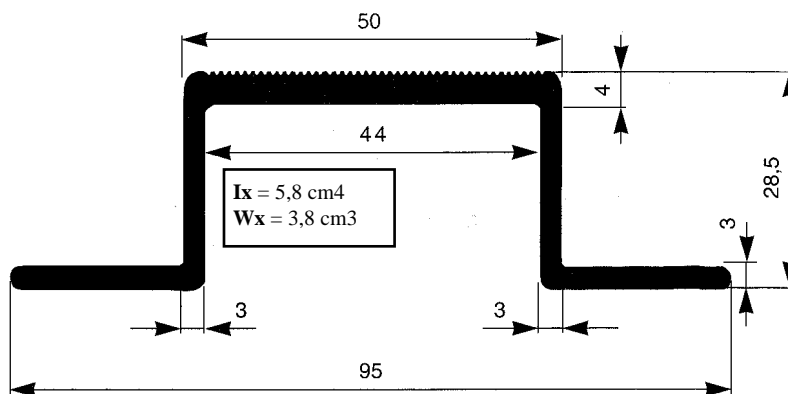

FL 06665
0,94 kg/m
code
401041 7,80 m

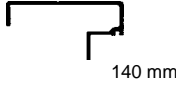

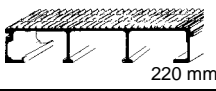
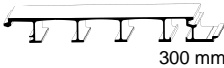
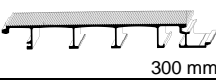
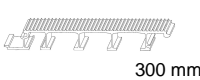
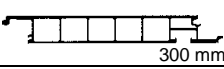
FL 08141
1,30 kg/m
code
401442 13,50 m

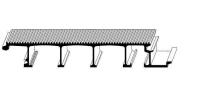
Blz. Page Seite	Profiel nr. Nr. de profil Profil Nr.	Gewicht Poids Gewicht	Symbool Symbole Symbol	Beschrijving Description Bezeichnung	Lengte Longueur Länge
B-2-2	CH 48924	3,12 kg/m	 140 mm	Randprofiel Seitenrandprofil	7,20 m
	DC 10937	3,55 kg/m	 155 mm	Profilé de rive	*
B-2-3	AL 12370	3,80 kg/m (17,52 kg/m ²)	 220 mm	Vloerprofiel glad Profilé de plancher lisse Bodenplanke glatt	7,50 m
	AS24524	4,03 kg/m (18,32 kg/m ²)	 220 mm	Vloerprofiel geribd Profilé de plancher canalé dentelé Bodenplanke geriffelt	7,50 m
B-2-4	AL 12368	6,61 kg/m (22,03 kg/m ²)	 300 mm	Vloerprofiel glad Profilé de plancher lisse Bodenplanke glatt	7,50 m
	AL 12369	6,07 kg/m (20,23 kg/m ²)	 300 mm	Vloerprofiel geribd	7,50 m
	AL 45330	7,15 kg/m (23,84 kg/m ²)	 300 mm	Profilé de plancher canalé dentelé	7,50 m
	CH 56807	7,76 kg/m (25,87 kg/m ²)	 300 mm	Bodenplanke geriffelt	7,50 m
B-2-5	CH 57928	4,92 kg/m	 271 mm	Vloerprofiel	13,50
	AL 45814	5,80 kg/m	 275 mm	Profilé de plancher canalé dentelé	7,50 m

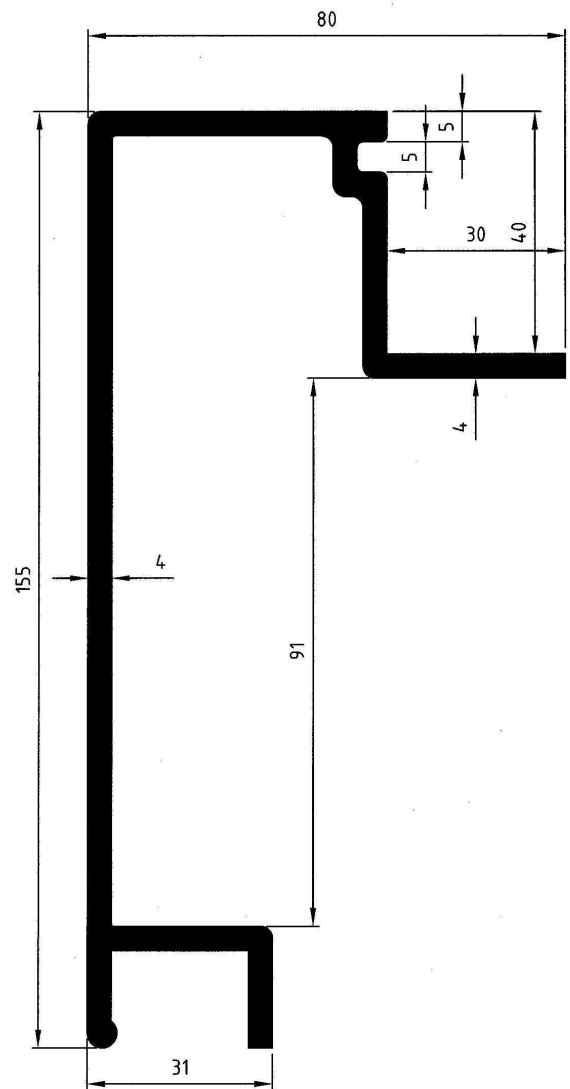
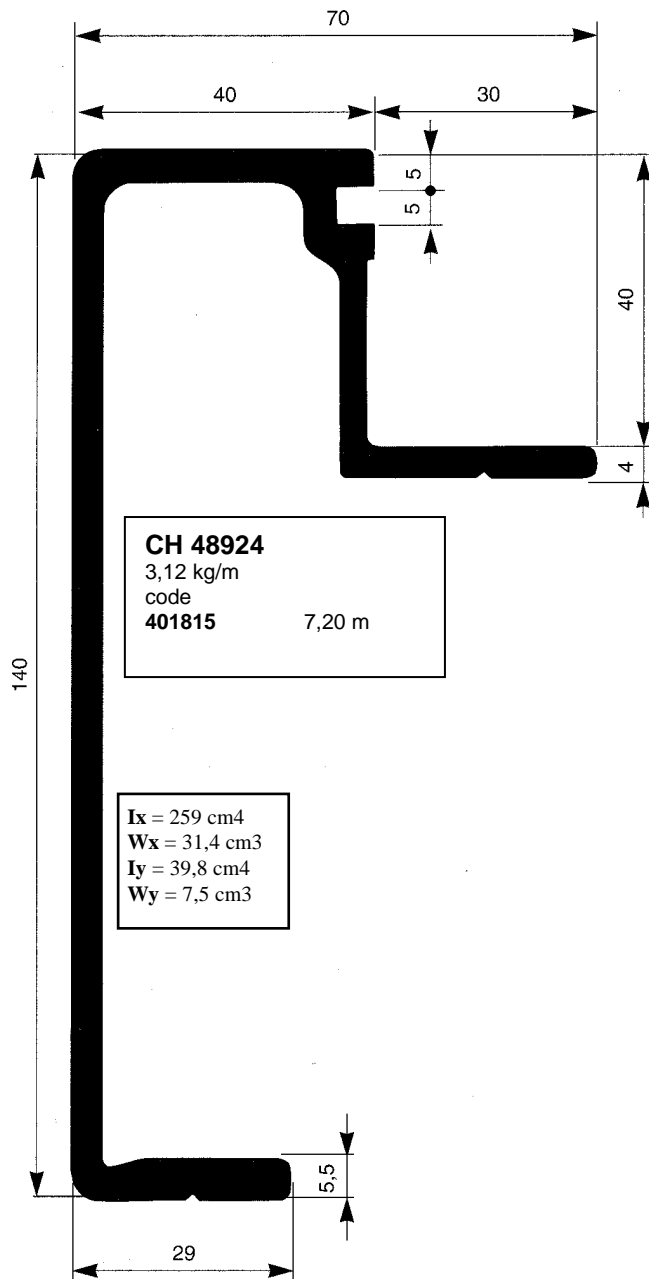

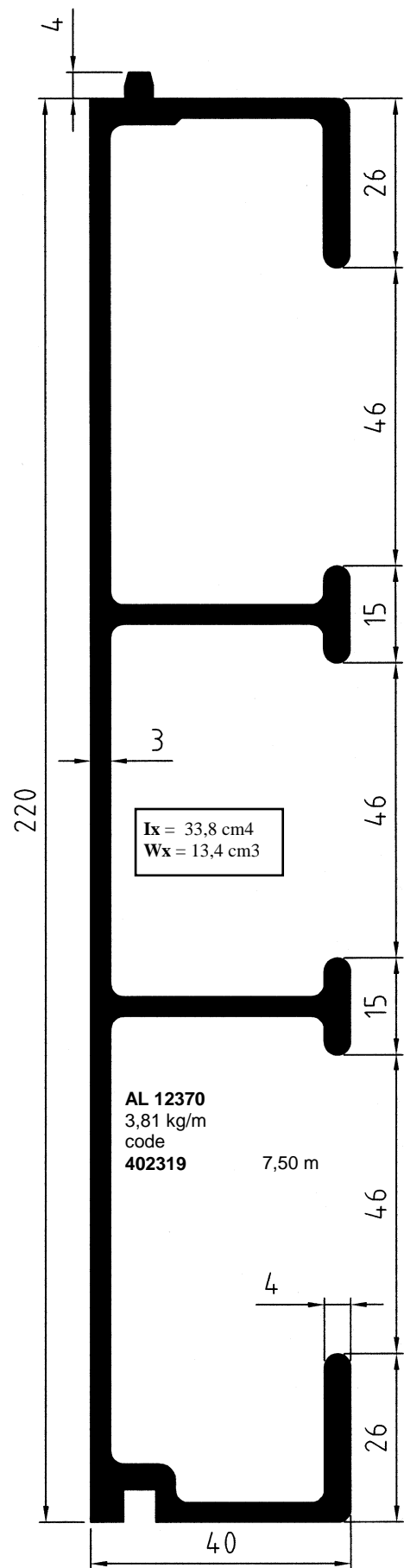
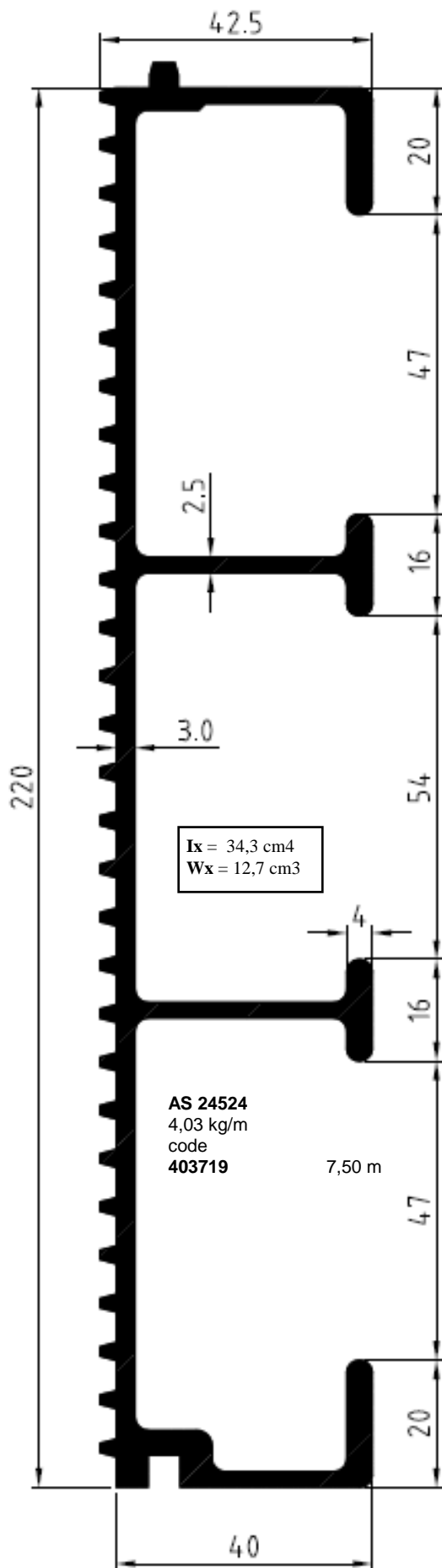

**Laadbak / vloeren
Plateau / plancher
Pritsche / Boden**

40 mm

B-2-4

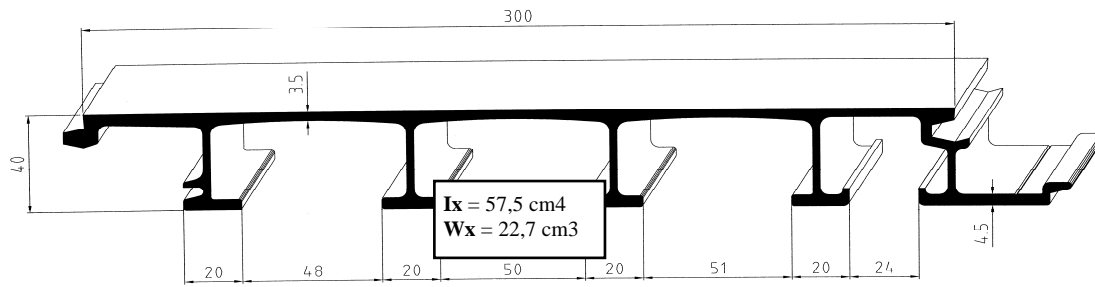

AL 12368
6,61 kg/m
code
406817 7,50 m

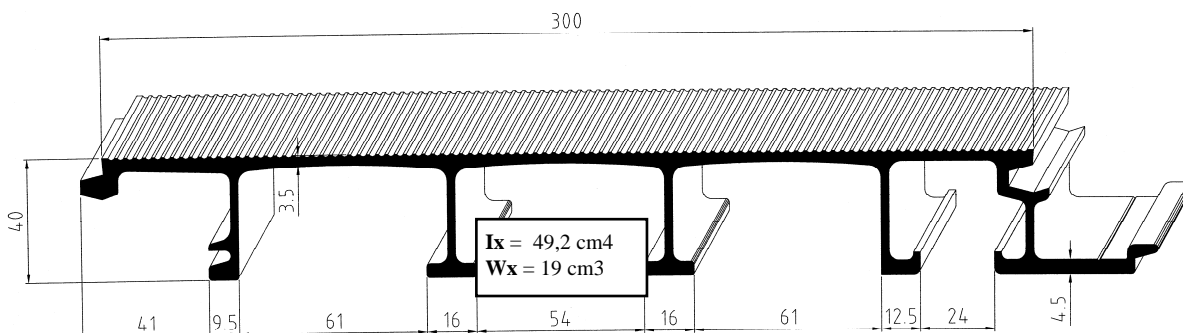

AL 12369
6,07 kg/m
code
406917 7,50 m

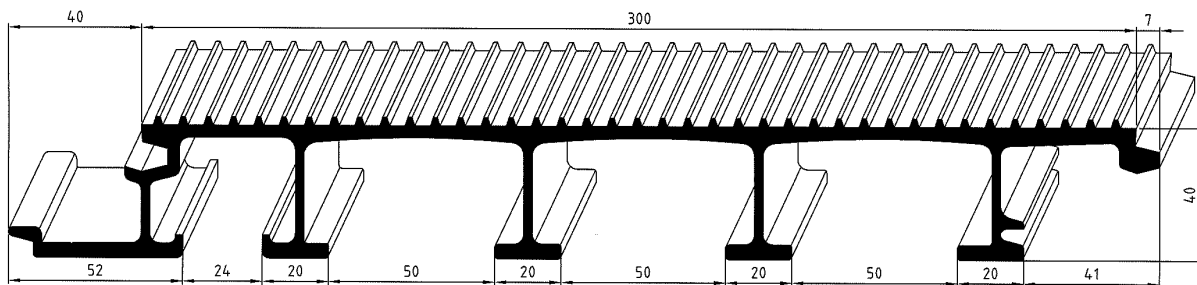

AL 45330
7,15 kg/m
code
1104901 7,50m

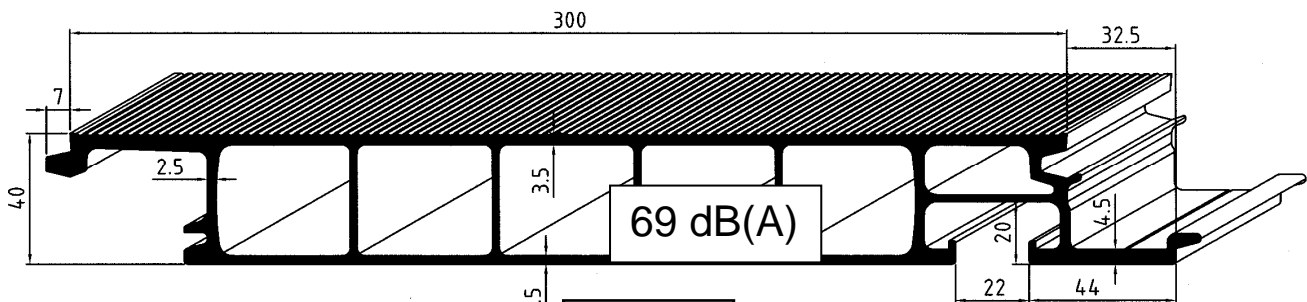

CH 56807
7,76 kg/m
code
404017 7,50 m

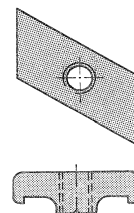

AG 5349-94
0,03 kg/st-p
code
446031

Andere 40 mm. vloerprofielen: zie ook blz.
40 mm. Profilé de plancher autres: voir page **C-1-2**
40 mm. Bodenprofilen: Siehe Seite

Geluidsarme aluminium vloeren Plancher en aluminium bruit limité Geräuscharmen Aluminium Boden

B-2-5

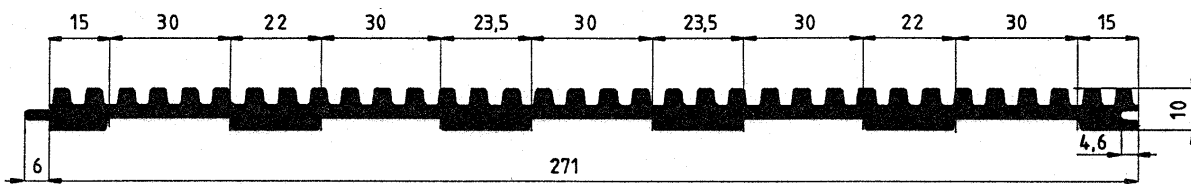
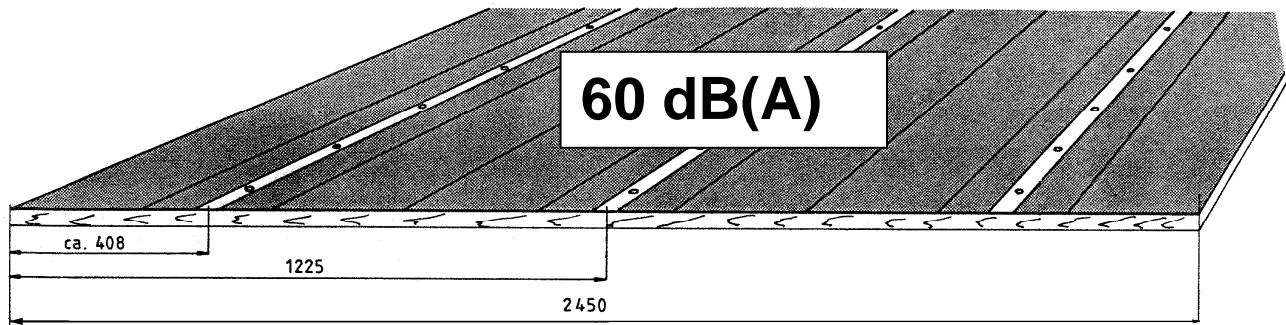

CH 57928
4,92 kg/m
code
425842 13,50 m

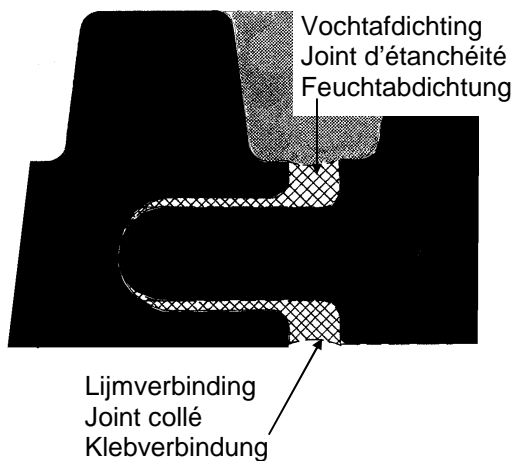

Dwars anti-slip 6mm
Quer-riflung
Cross-dérapant

AL 45814
5,80 kg/m
code
1104728 7,50 m

